









**FUNDE AUS FRÜHMITTELALTERLICHEN GRÄBERN
UND GRÄBERFELDERN
AUF DER GEMARKUNG SINDELFINGEN
UND AUS DEM NÖRDLICHEN OBEREN GÄU**

Tafeln

Legende zu den Ausschnitten aus den TK 1:25000 (Taf. 74-82)

-  Einzelgräber
-  Gräberfeld
-  Einzelfund
-  Einzelfunde und –befunde in alten Siedlungskernen
-  Wüstung
-  Kirche
-  Burg
-  Altstraße, Verlauf gesichert
-  Altstraße, Verlauf nicht gesichert

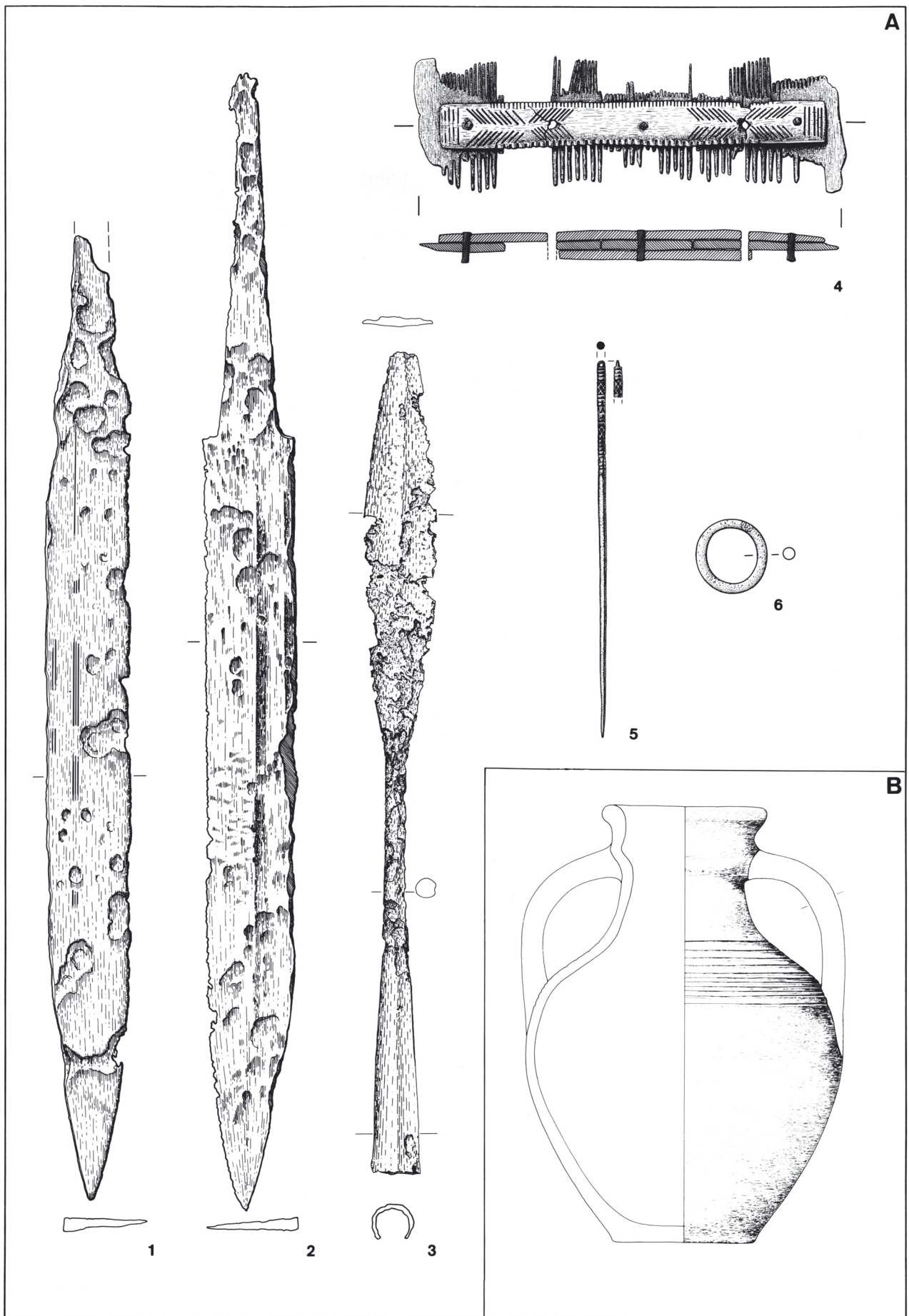

Sindelfingen (Fst. 1). A 8489; B 8162-8192. A 1-3, B M 1:3; A 4-6 M 1:2.

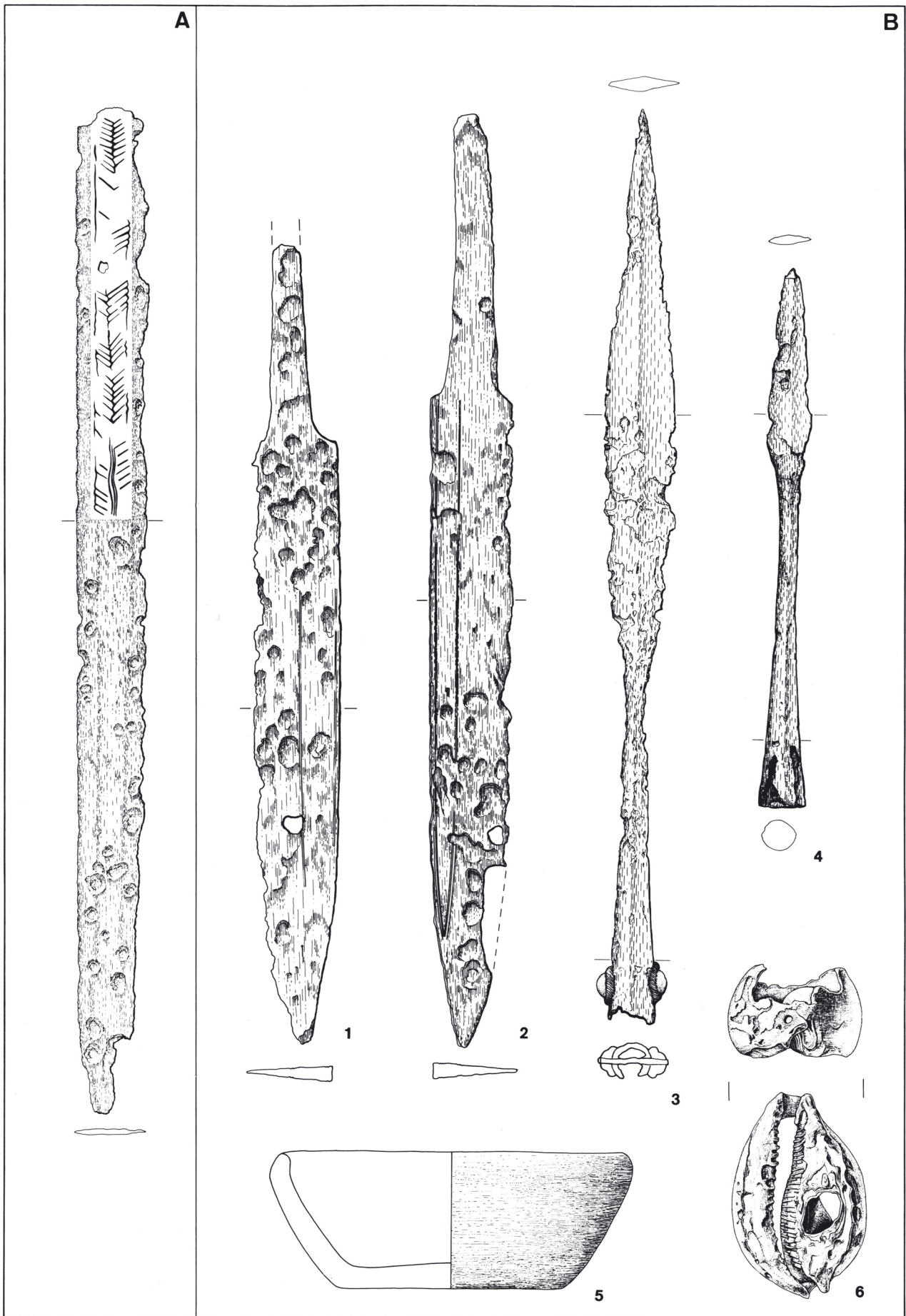

Sindelfingen (Fst- 1). A 8648; B 8538/8539. A M 1:4; B 1-4 M 1:3; B 5.6 M 1:2.

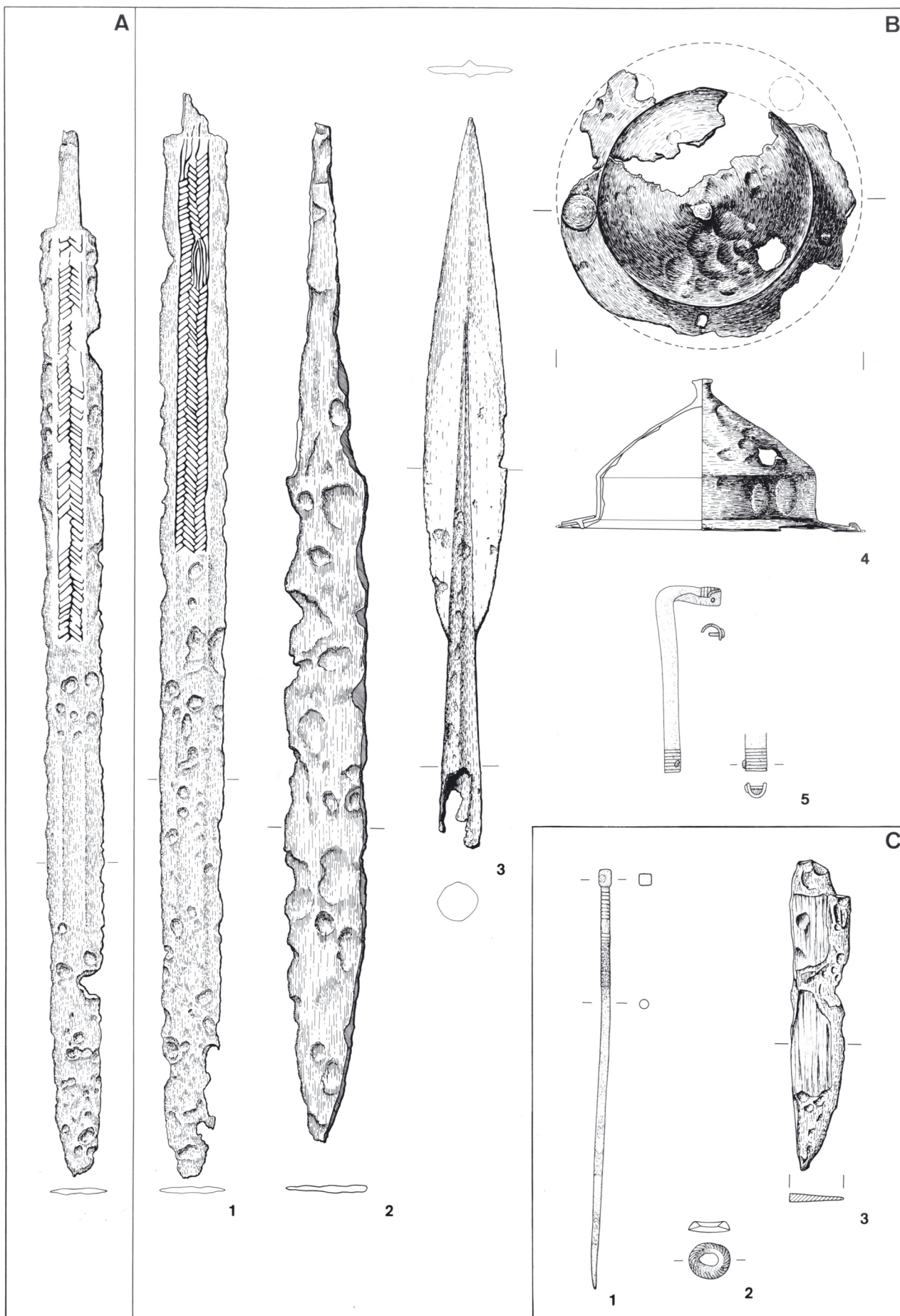

Sindelfingen (Fst. 1). A 8876; B 8754; C 8670. A, B 1 M 1:4; B 2-4 M 1:3; B 5, C 1-3 M 1:2.

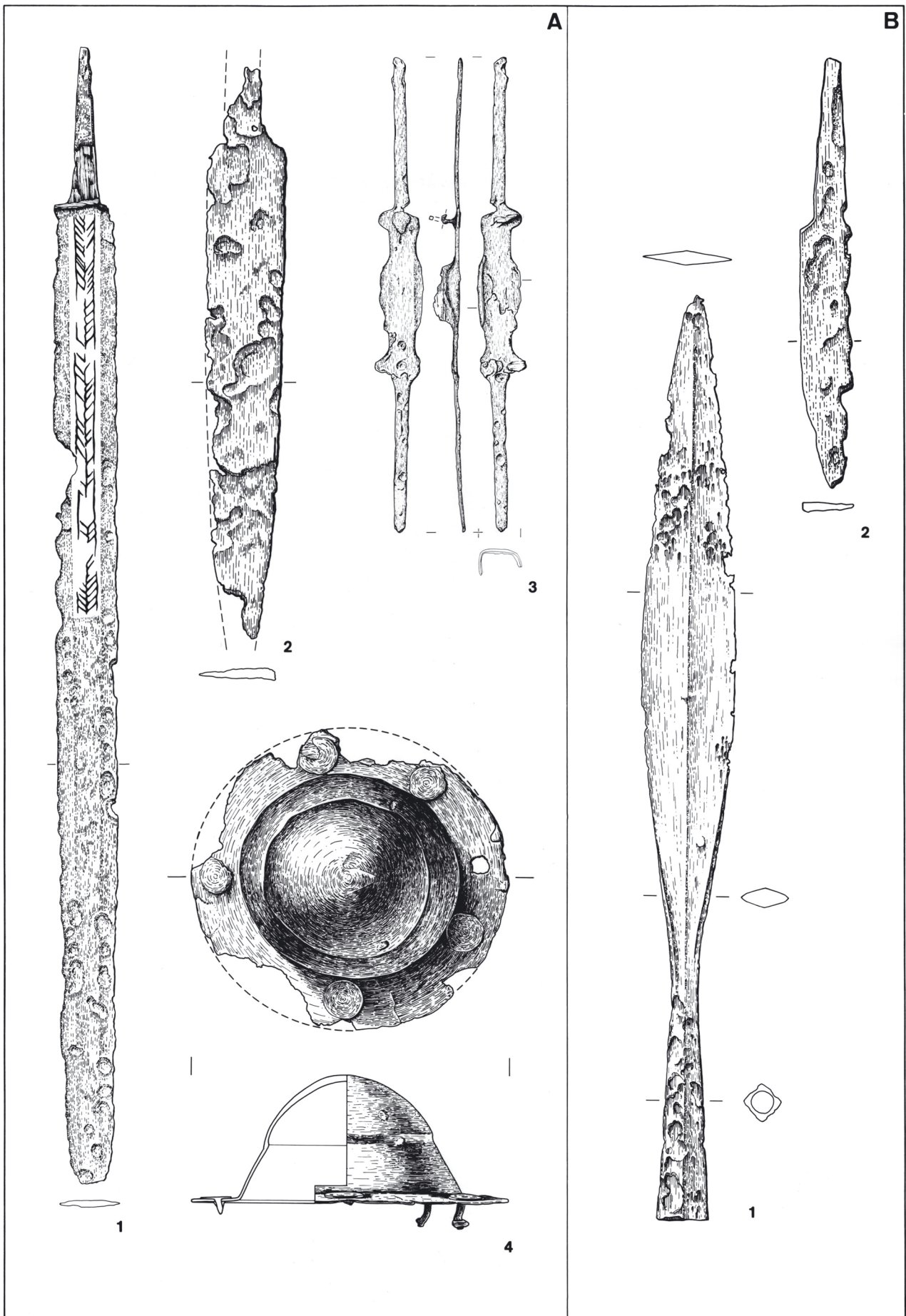

Sindelfingen (Fst. 1). A 8670; B 8566. A 1.3 M 1:4; A 2.4, B 1 M 1:3; B 2 M 1:2.

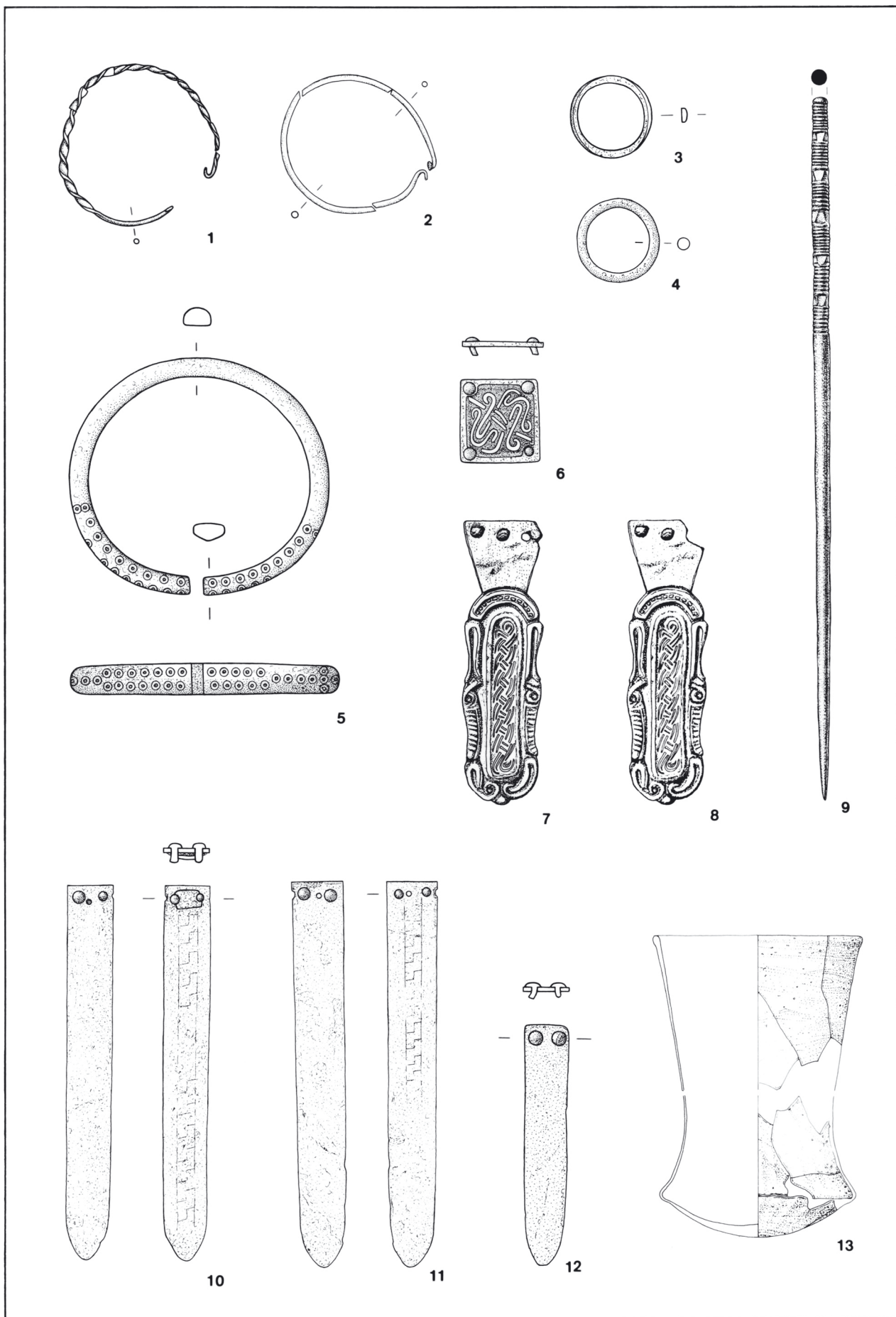

Sindelfingen (Fst. 1). 8820. M 2:3.

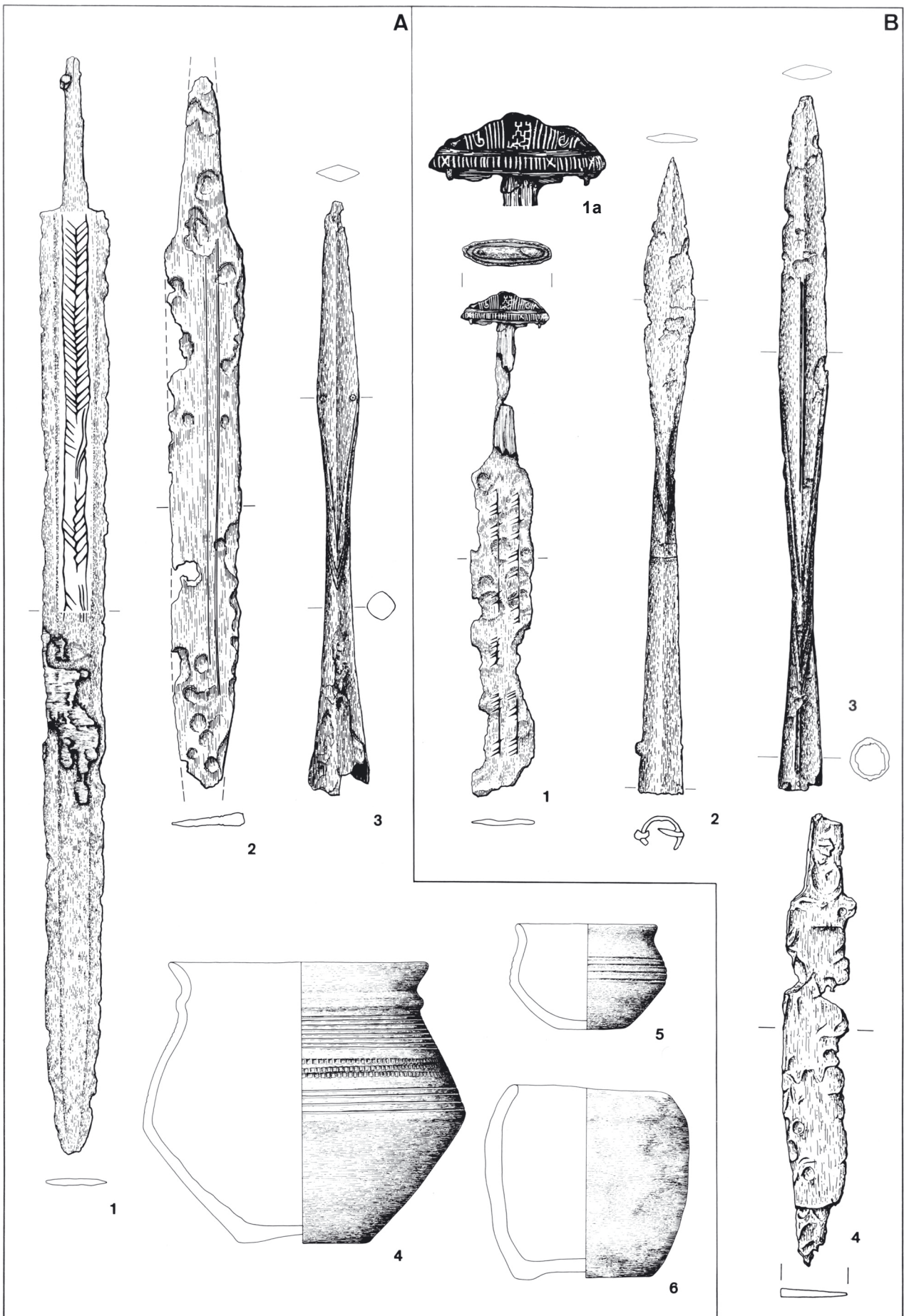

Sindelfingen (Fst. 1). A 10350; B 9199. A 1, B 1 M 1:4; A 2-6, B 2.3 M 1:3; B 1a.4 M 1:2.

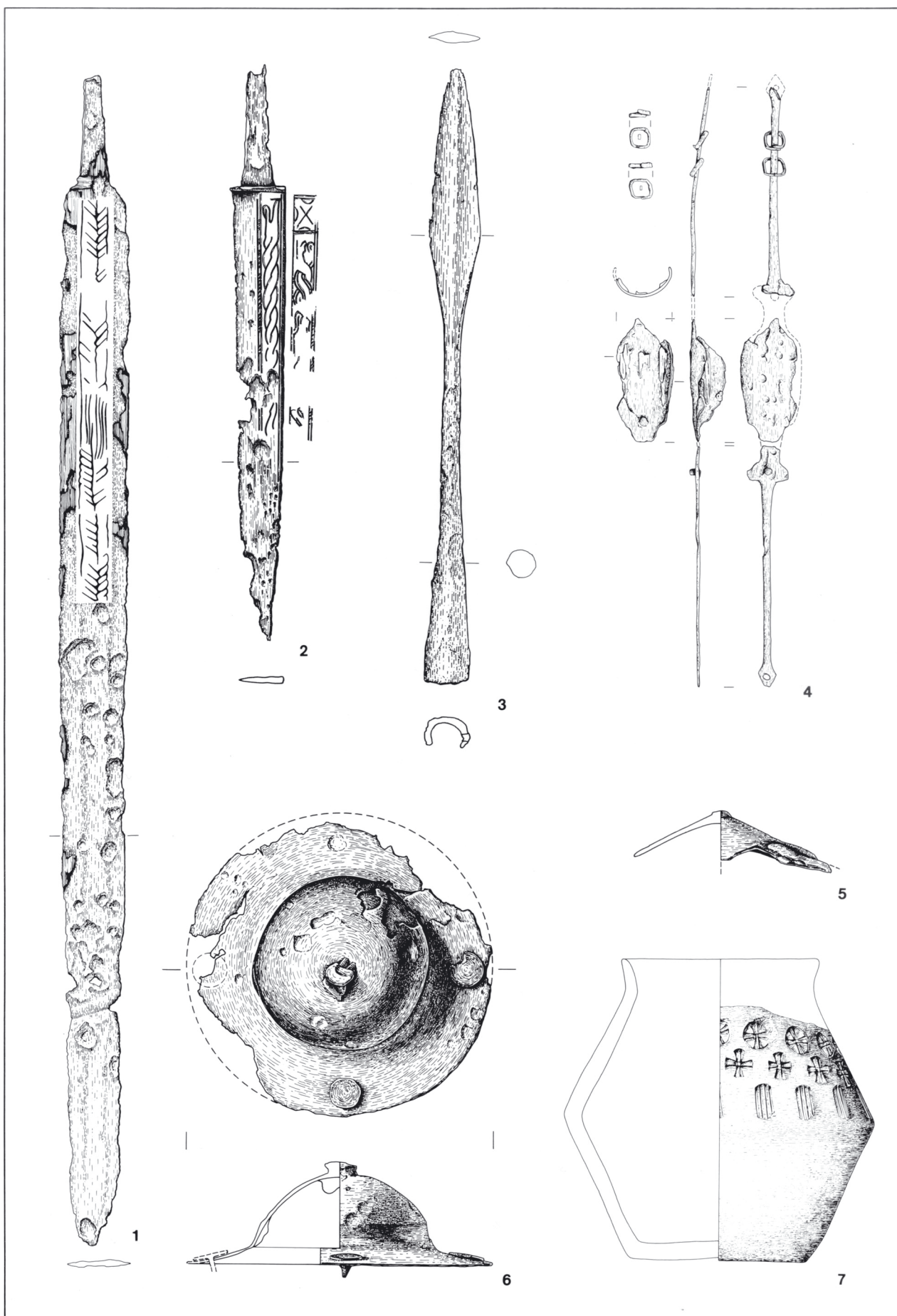

Sindelfingen (Fst. 1). 9377. 1.4 M 1:4; 2.3.5.6 M 1:3.

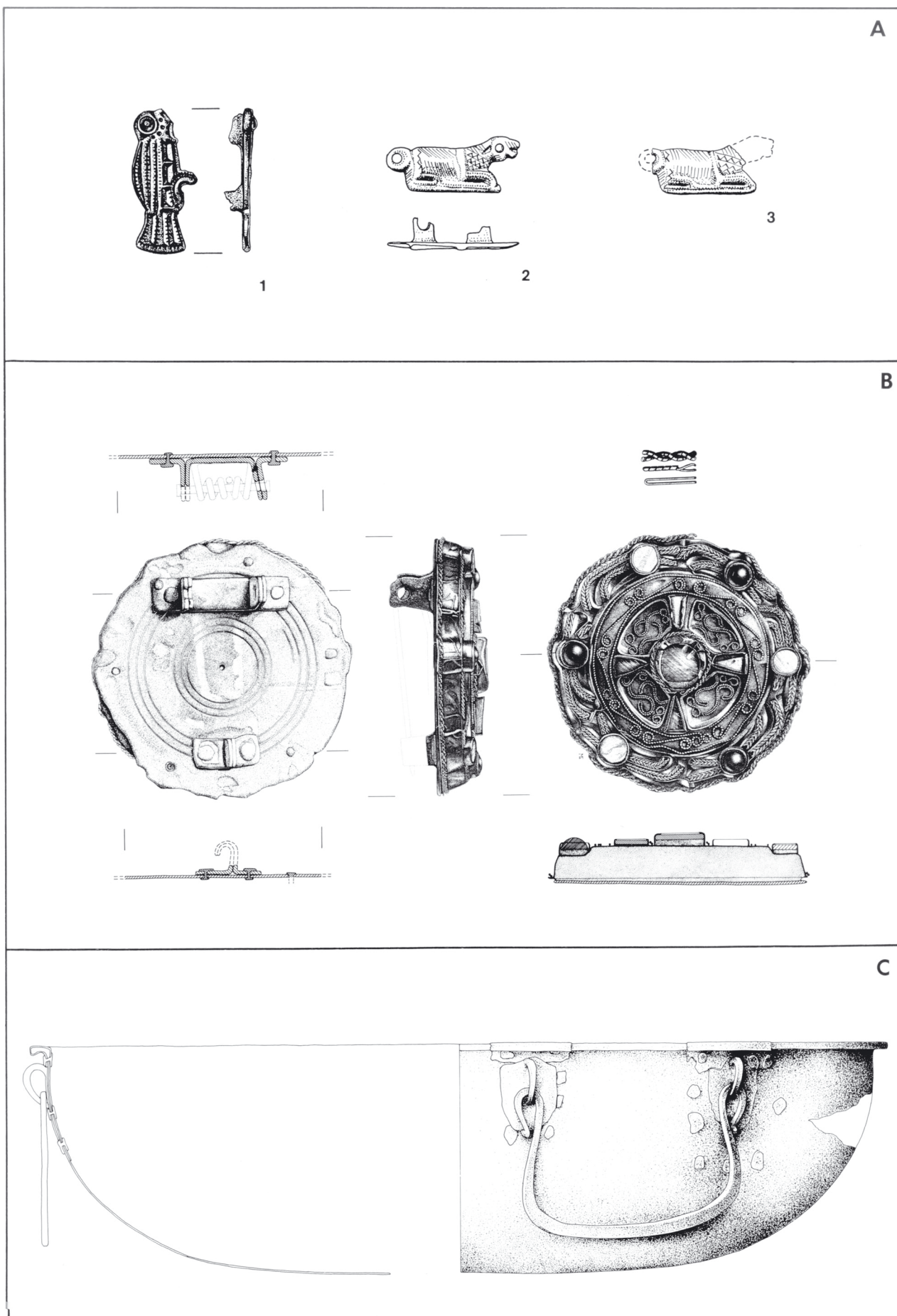

Sindelfingen (Fst. 1). A 10743; B 9377; C 8794. A 1-3; B M 1:1; C M 1:2.

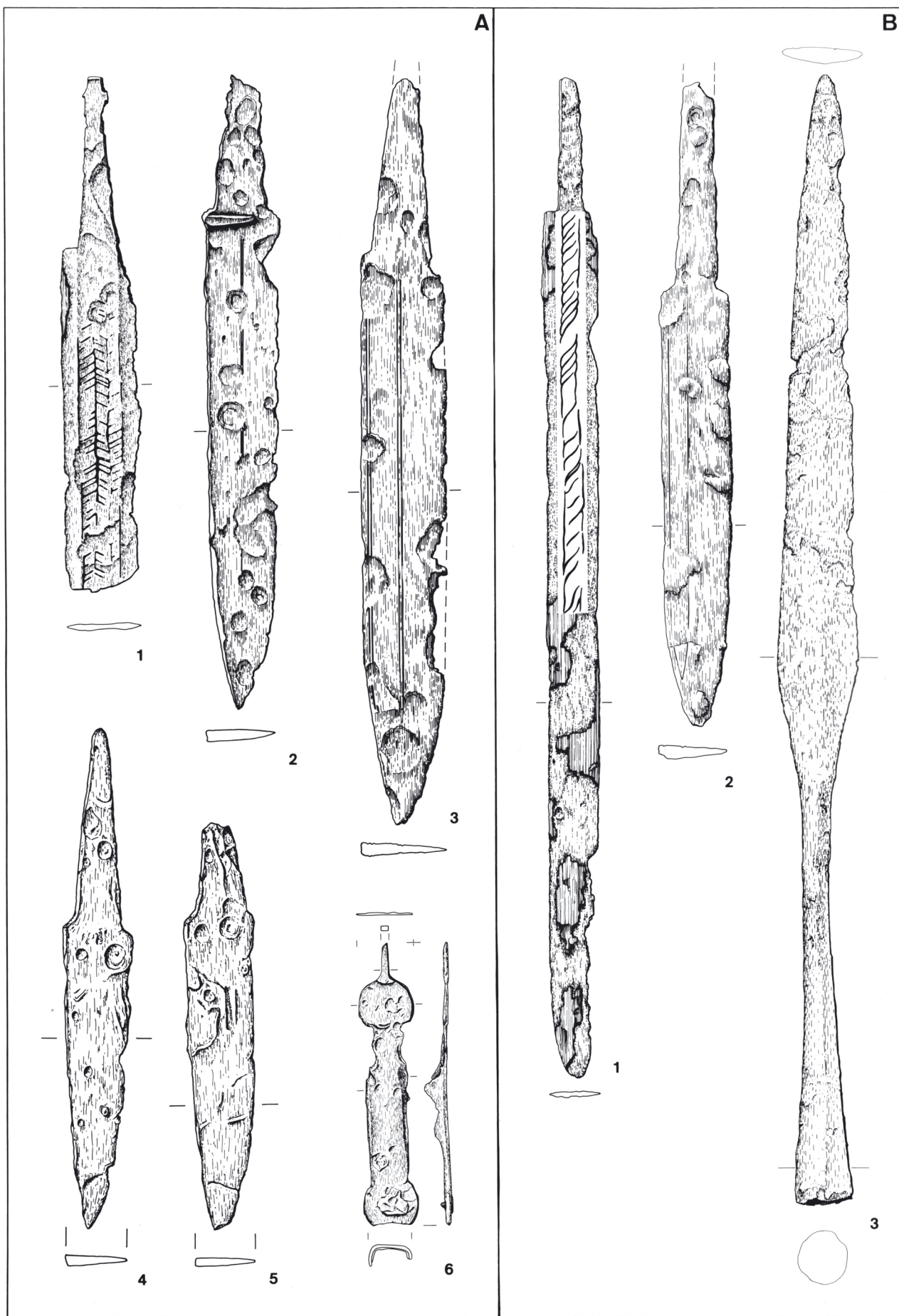

Sindelfingen (Fst. 1). A 11265; B 10071. A 1.6, B 1 M 1:4; A 2.3, B 2.3 M 1:3; A 4.5 M 1:2.

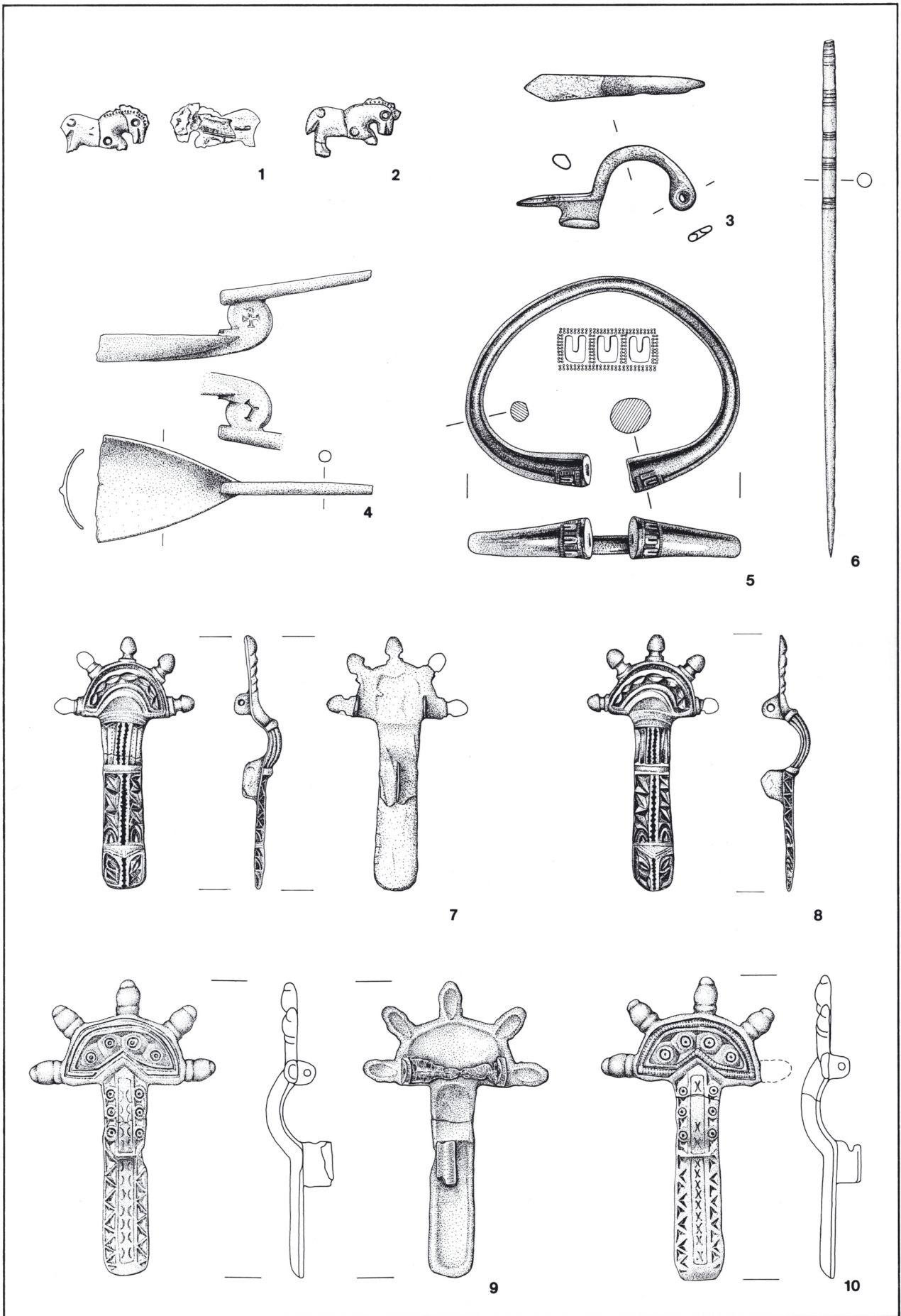

Sindelfingen (Fst. 1). 1.2.4 10071; 3.5.6 11265; 7-10 10071/11265. M 2:3.

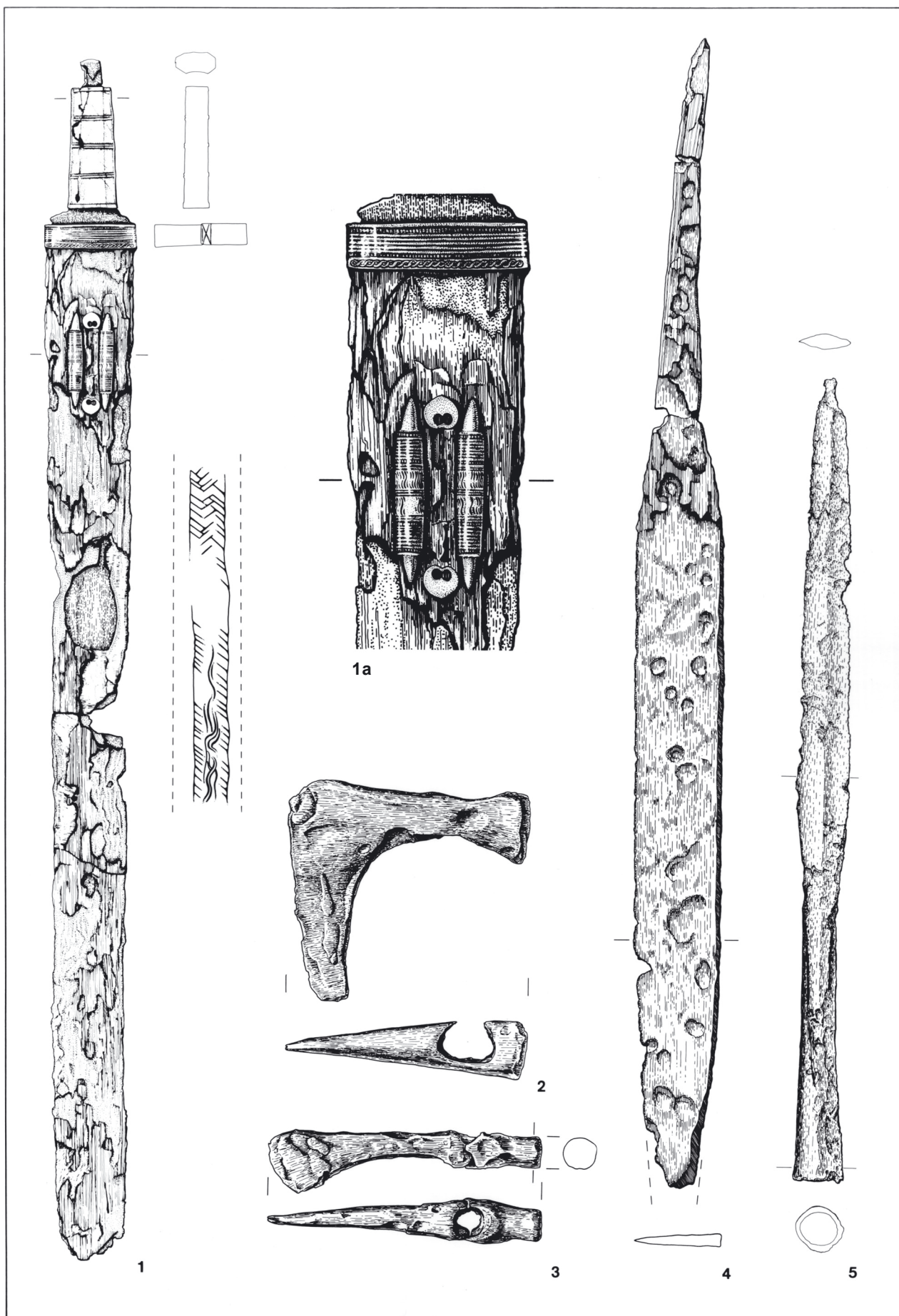

Sindelfingen (Fst. 1). 10453. 1 M 1:4 u. 1a cxdM 1:2; 2-5 M 1:3.

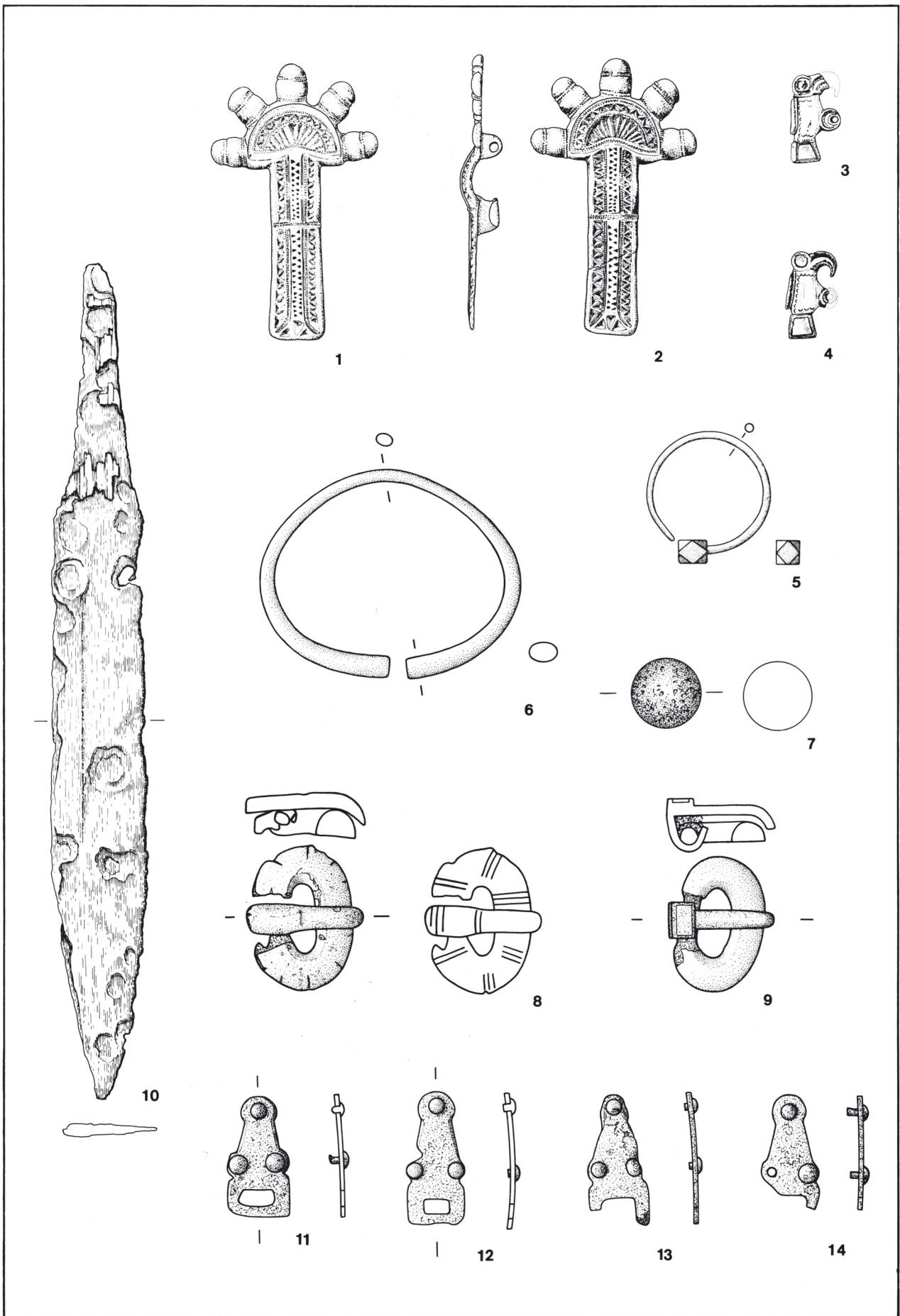

Sindelfingen (Fst. 1). 10670. 1 M 1:3; 2-14 M 2:3.

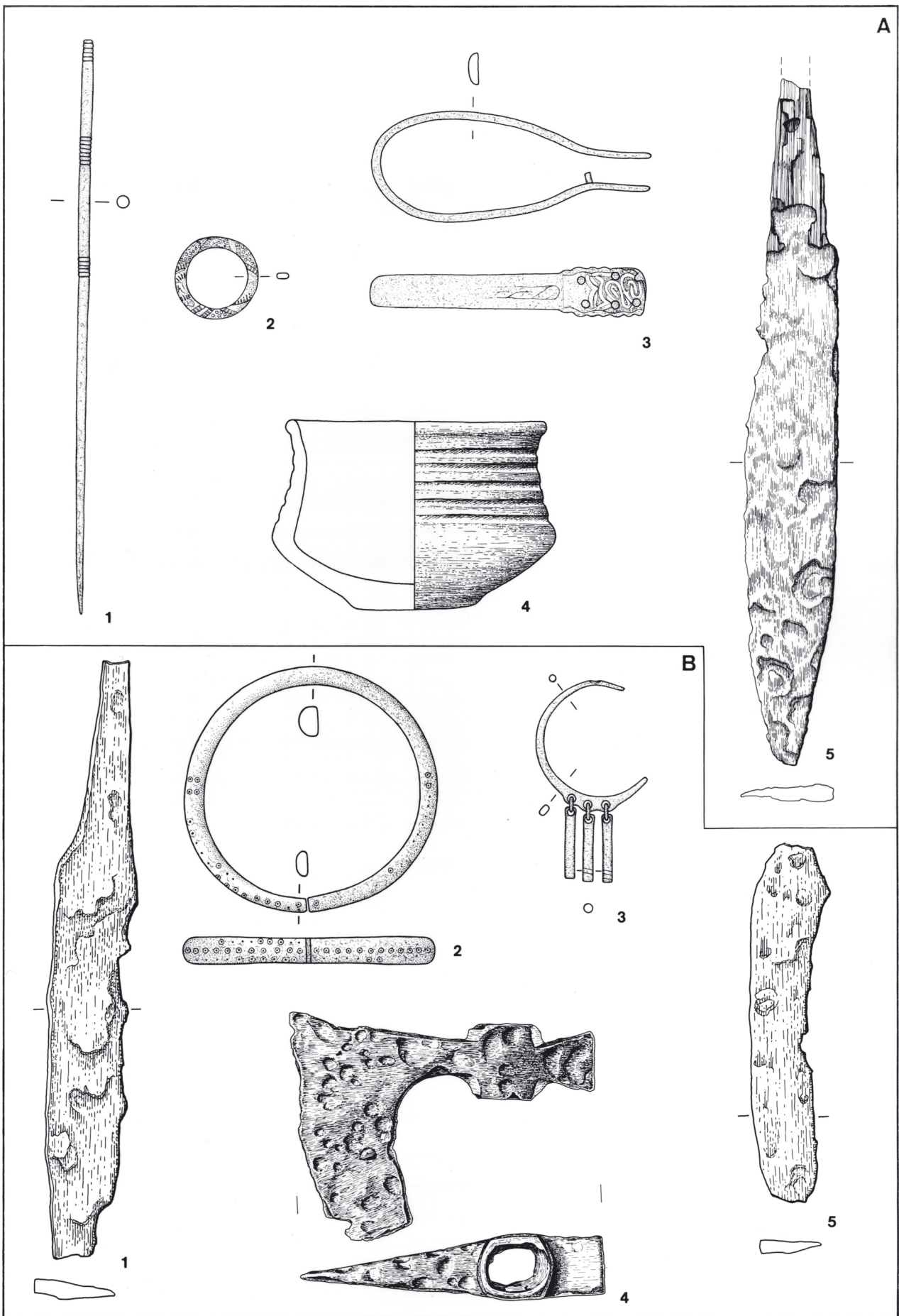

Sindelfingen (Fst. 1). A 10843; B 10499. A 1-4, B 1-3.5 M 2:3; A 5, B 4 M 1:3.

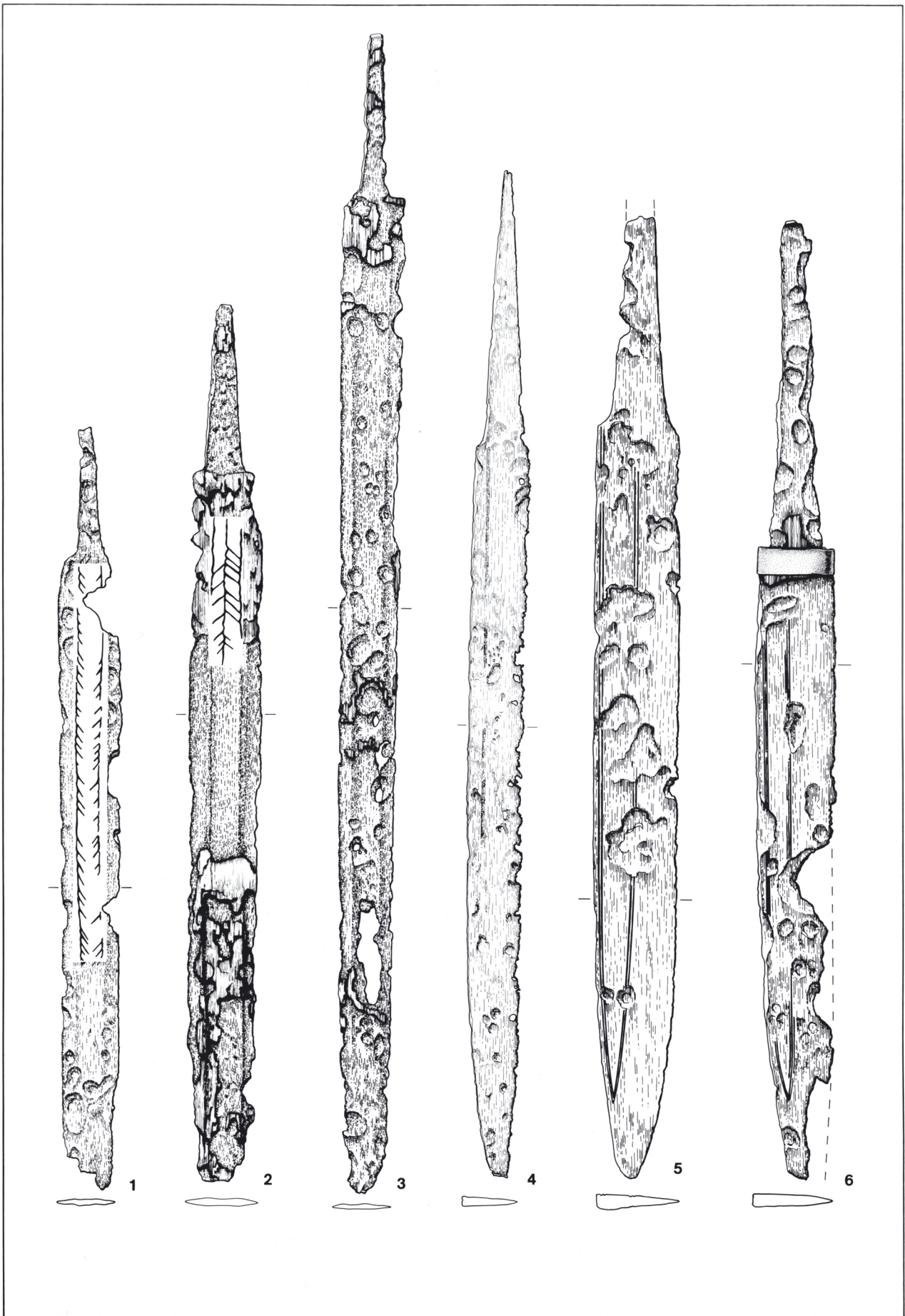

Sindelfingen (Fst. 1). 11351,1-6. 1-4 M 1:4; 5,6 M 1:3.

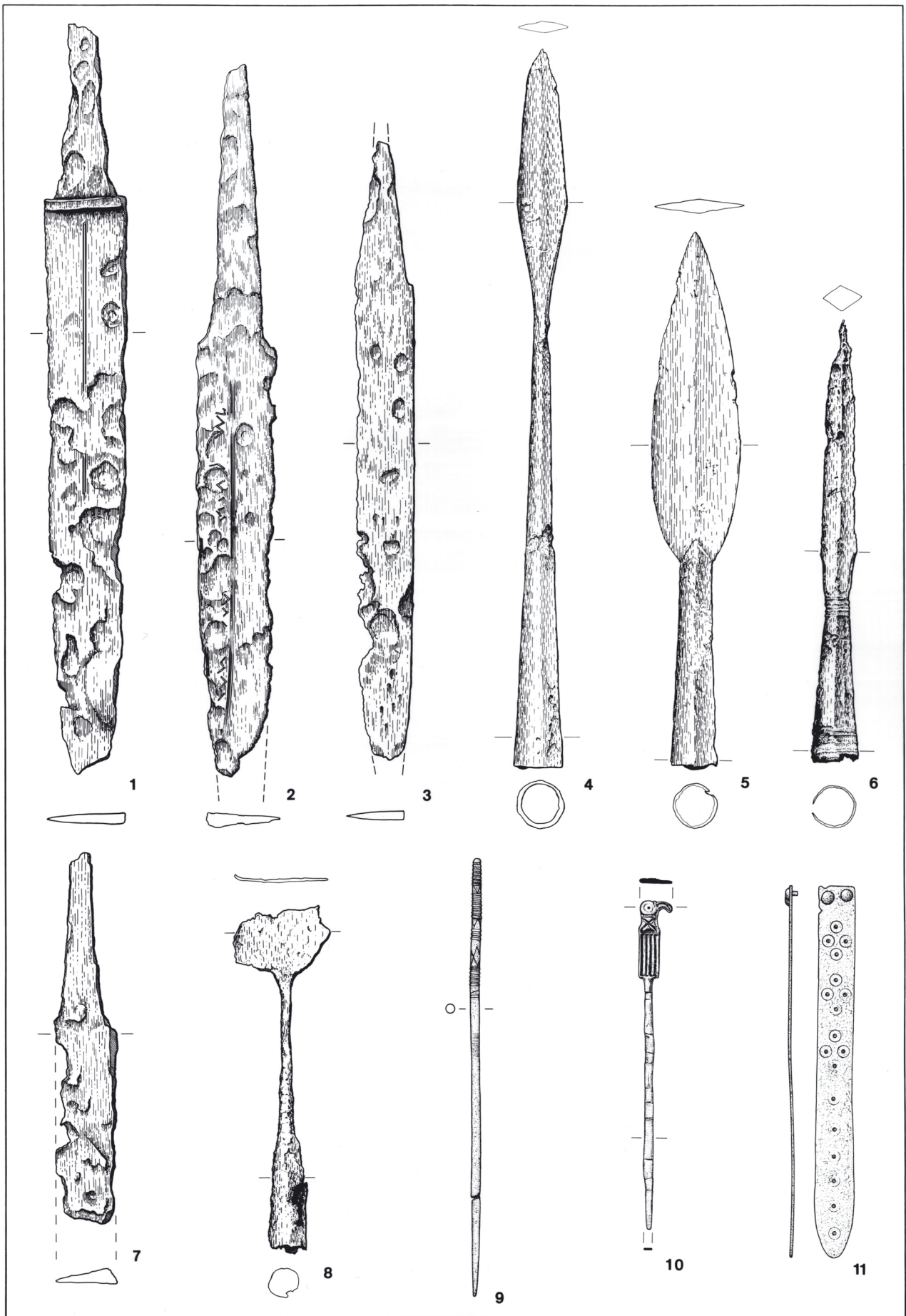

Sindelfingen (Fst. 1). 11351,7-14.25-27.42.48. 1-8 M 1:3; 9-12 M 1:2.

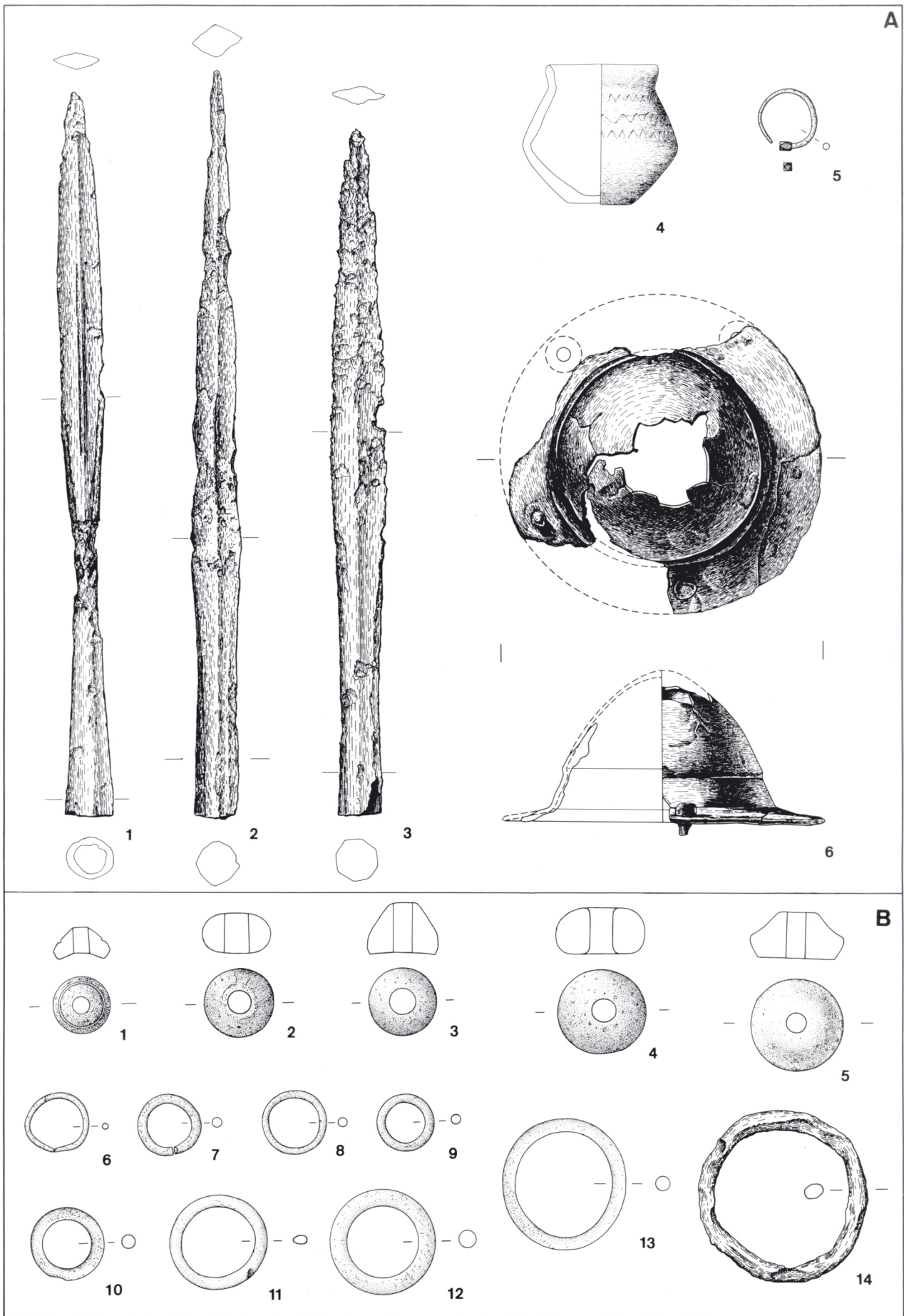

Sindelfingen (Fst. 1). A 11351,15-18.56; B 1-5 Spinnwirtel F 84/29,21-25; 6-14 Ringe F 84/30,1-9. A M 1:3; B M 1:2.

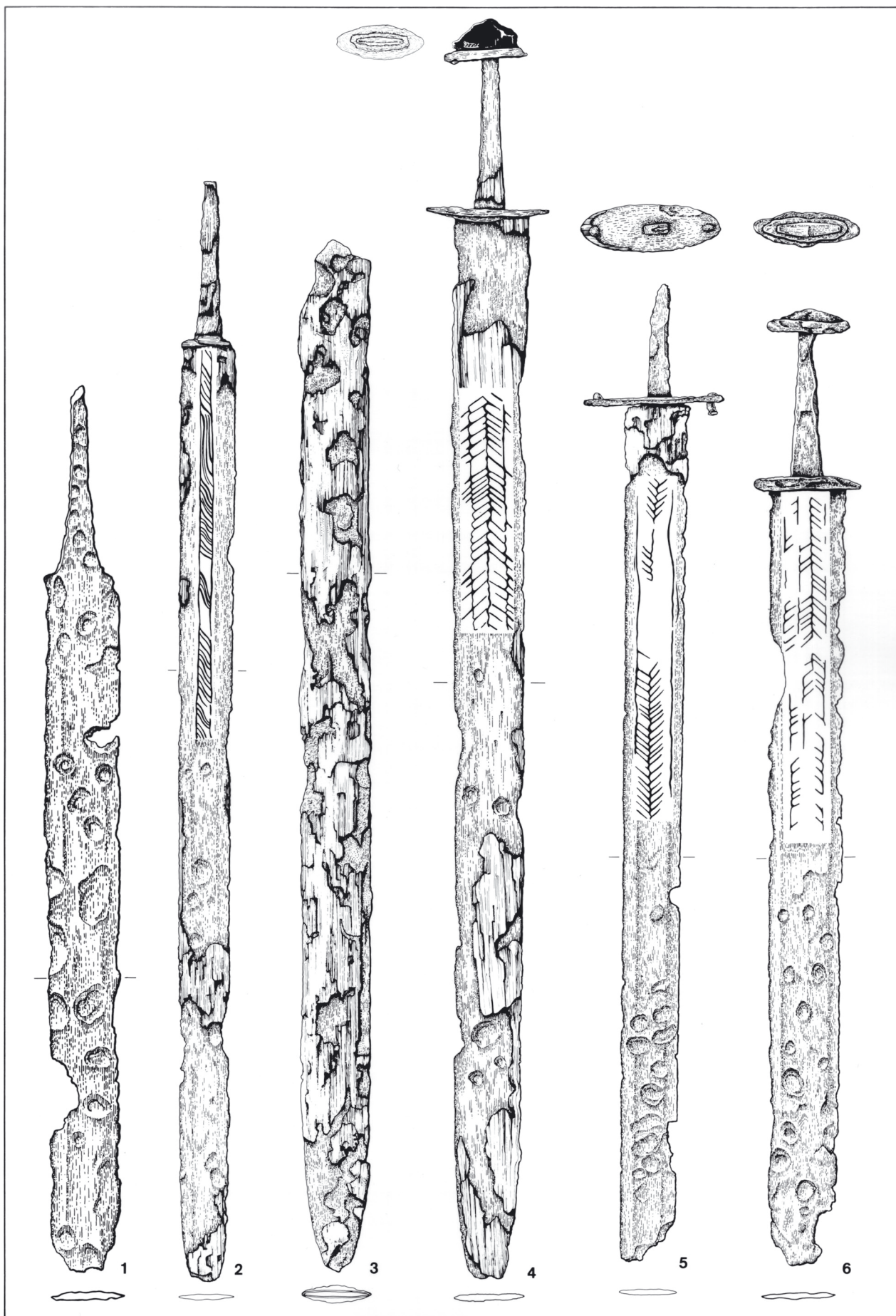

Sindelfingen (Fst. 1). Spathen F 84/12, 1-6. M 1:4.

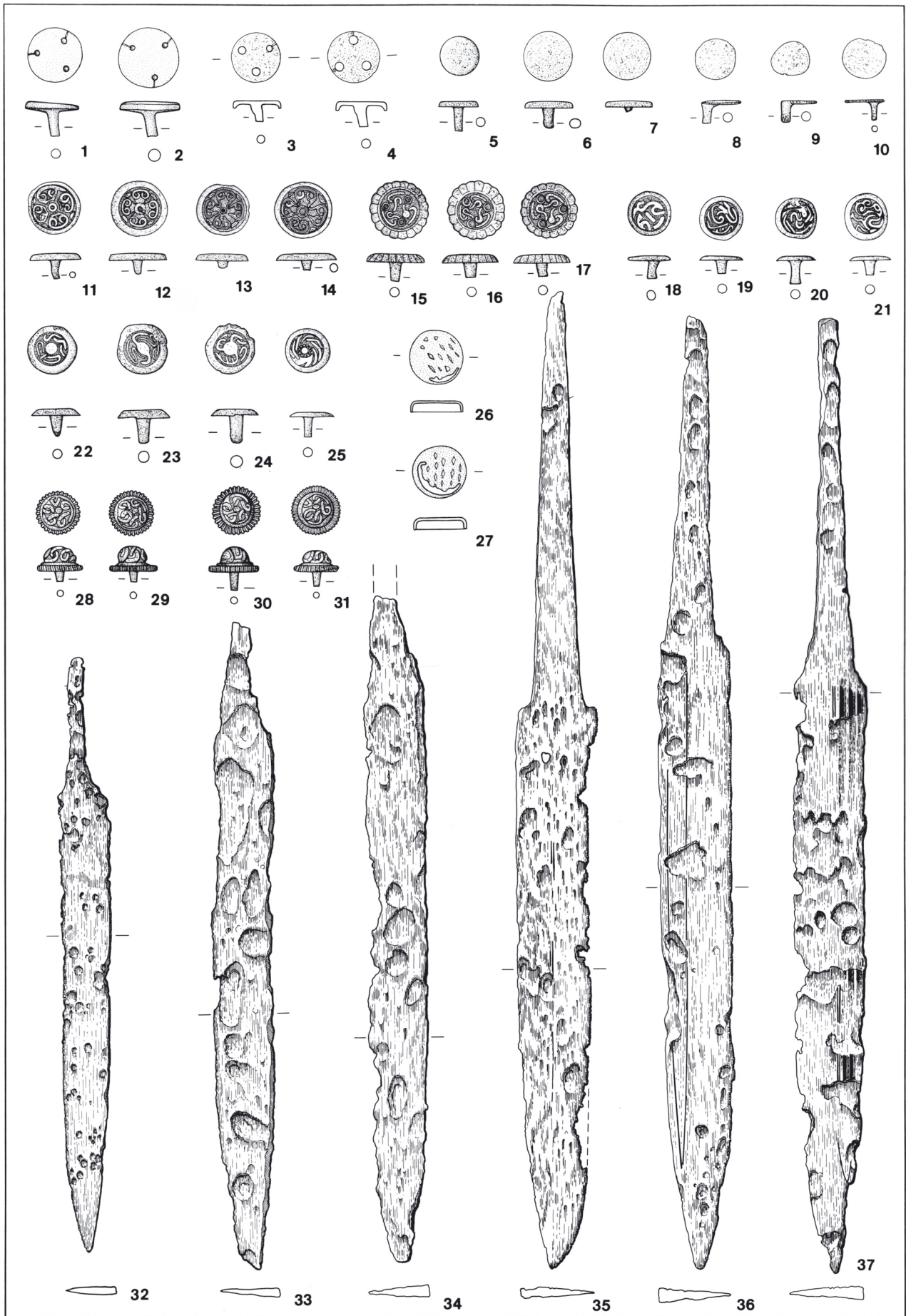

Sindelfingen (Fst. 1). Saxe und Saxscheidenknöpfe. 1-31 F 84/17, 1-13; 32-37 F 84/13, 1-6.
1-31 M 1:2; 32-37. M 1:3.

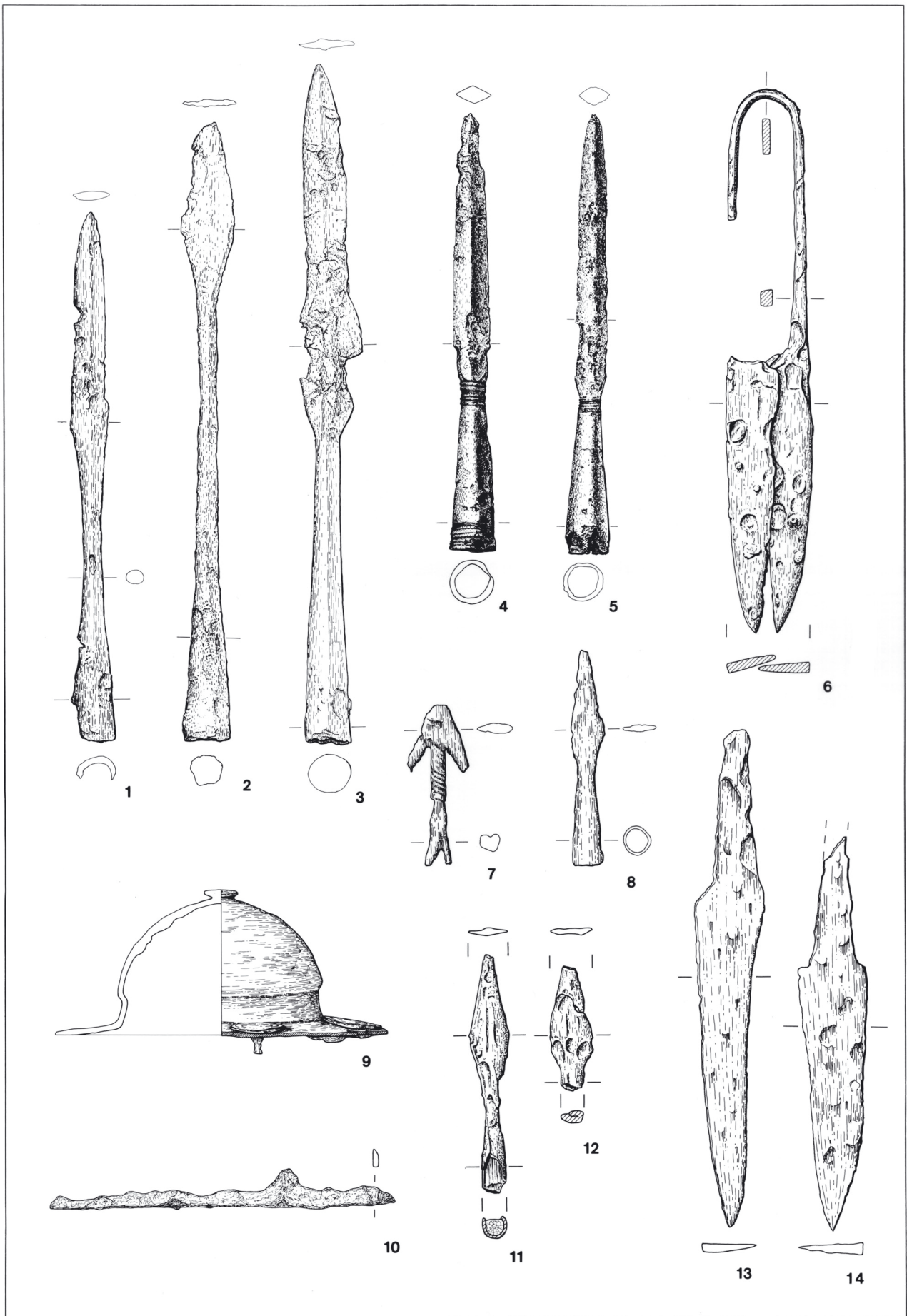

Sindelfingen (Fst. 1). Waffen und Geräte. 1-5 F 84/14,1-5; 9 F 84/15,1; 7.8.11.12 F 84/16,1-4; 6.13.14 F 84/29,1-3; 10 F 84/29,18. 1-5.9 M 1:3; 6-8.10-14 M 1:2.

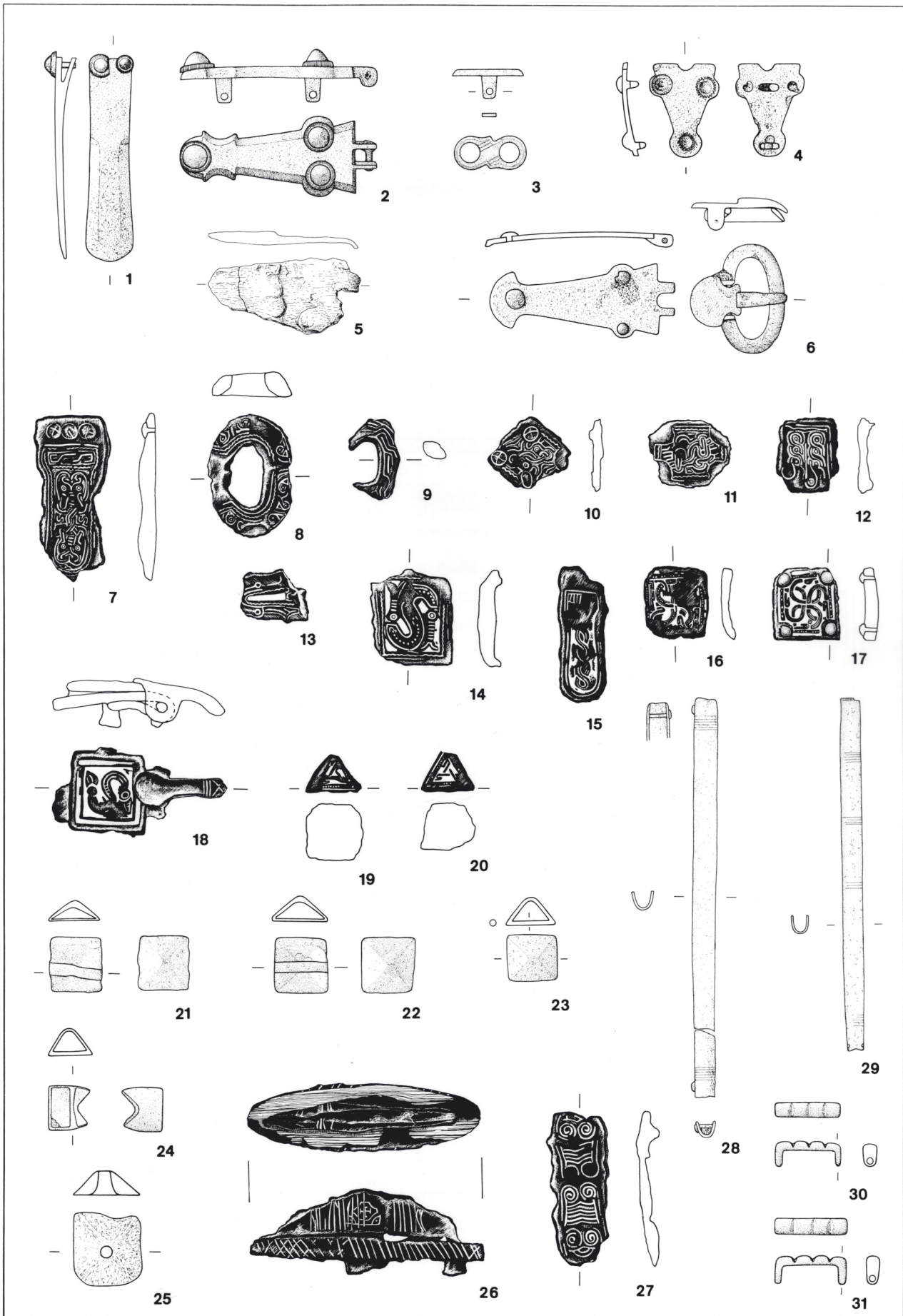

Sindelfingen (Fst. 1). Teile von Männnergürtelgarnituren, Spathagehängen, Reit- und Waffenzubehör. 1-25.27.30-31 F 84/18,37-63; 28.29 F 84/17,14.15; 26 F 84/12,7. M 1:2.

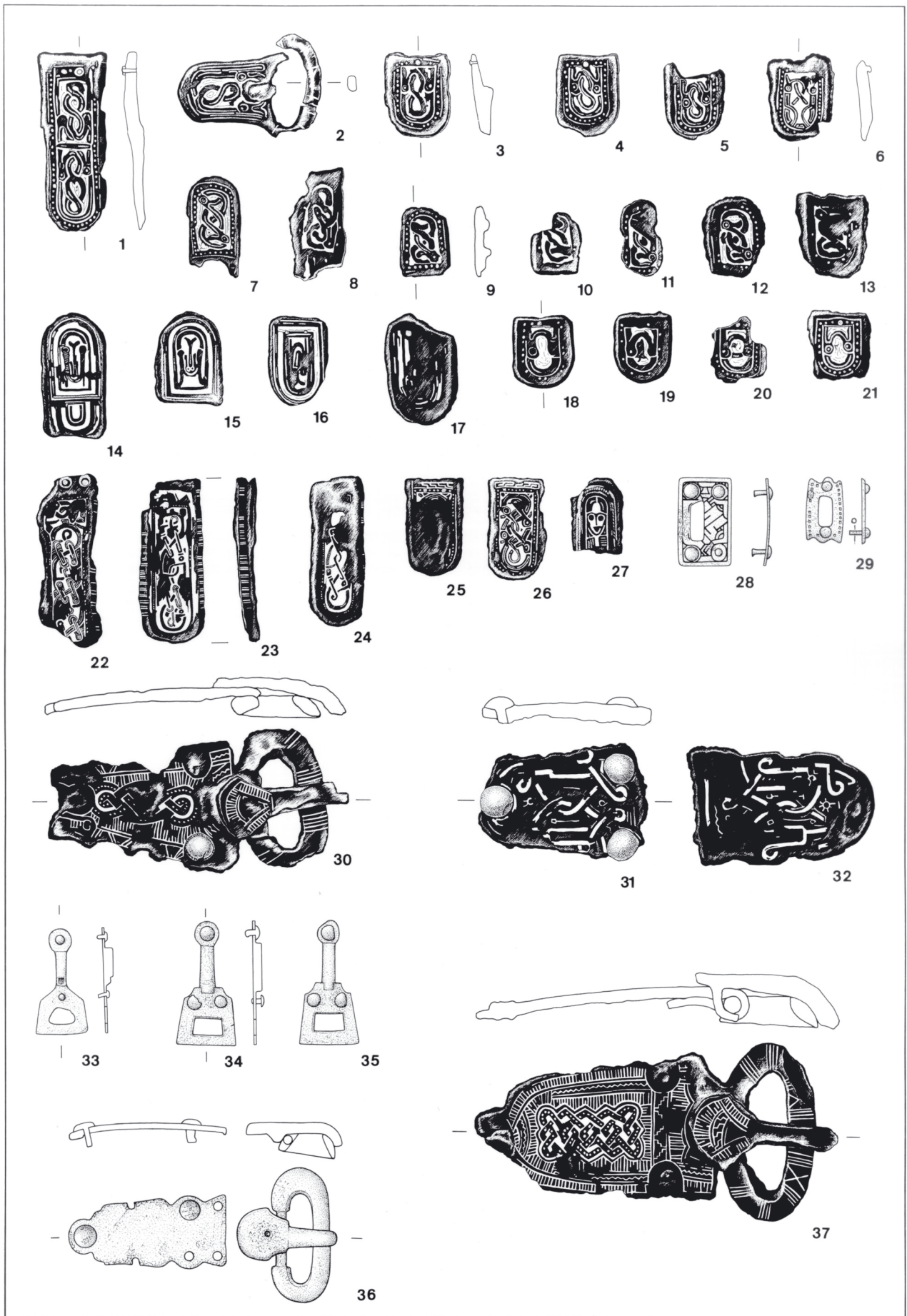

Sindelfingen (Fst. 1). Teile von Männnergürtelgarnituren. 1-37 F 84/18, 1-36. M 1:2.

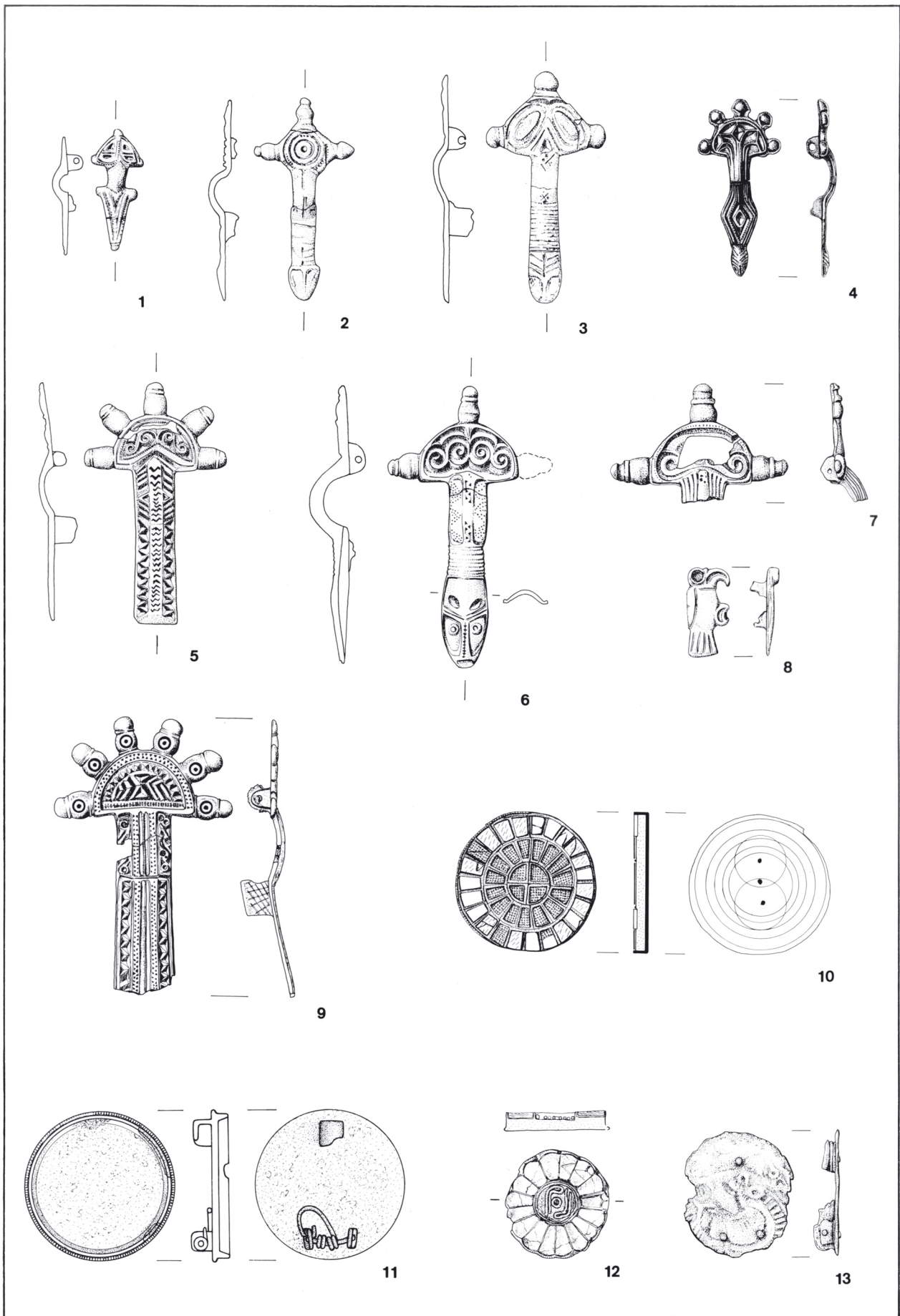

Sindelfingen (Fst. 1). Fibeln. 1-13 F 84/19,1-12. M 2:3.

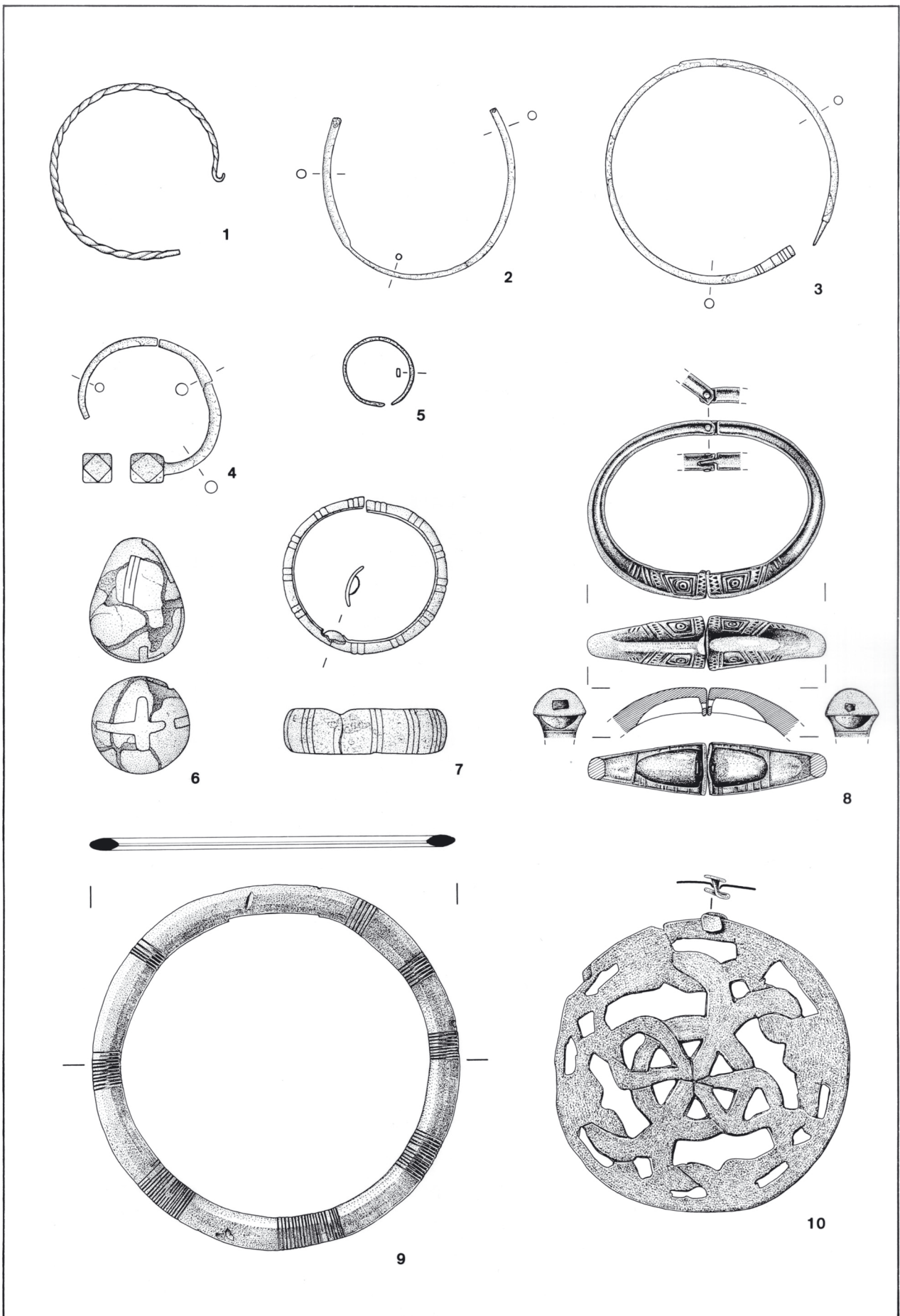

Sindelfingen (Fst. 1). Schmuck aus Frauengräbern. 1-5 F 84/21,1-4; 7.8 F 84/20,1.2; 6.9.10 F 84/24,1.2 M 2:3.

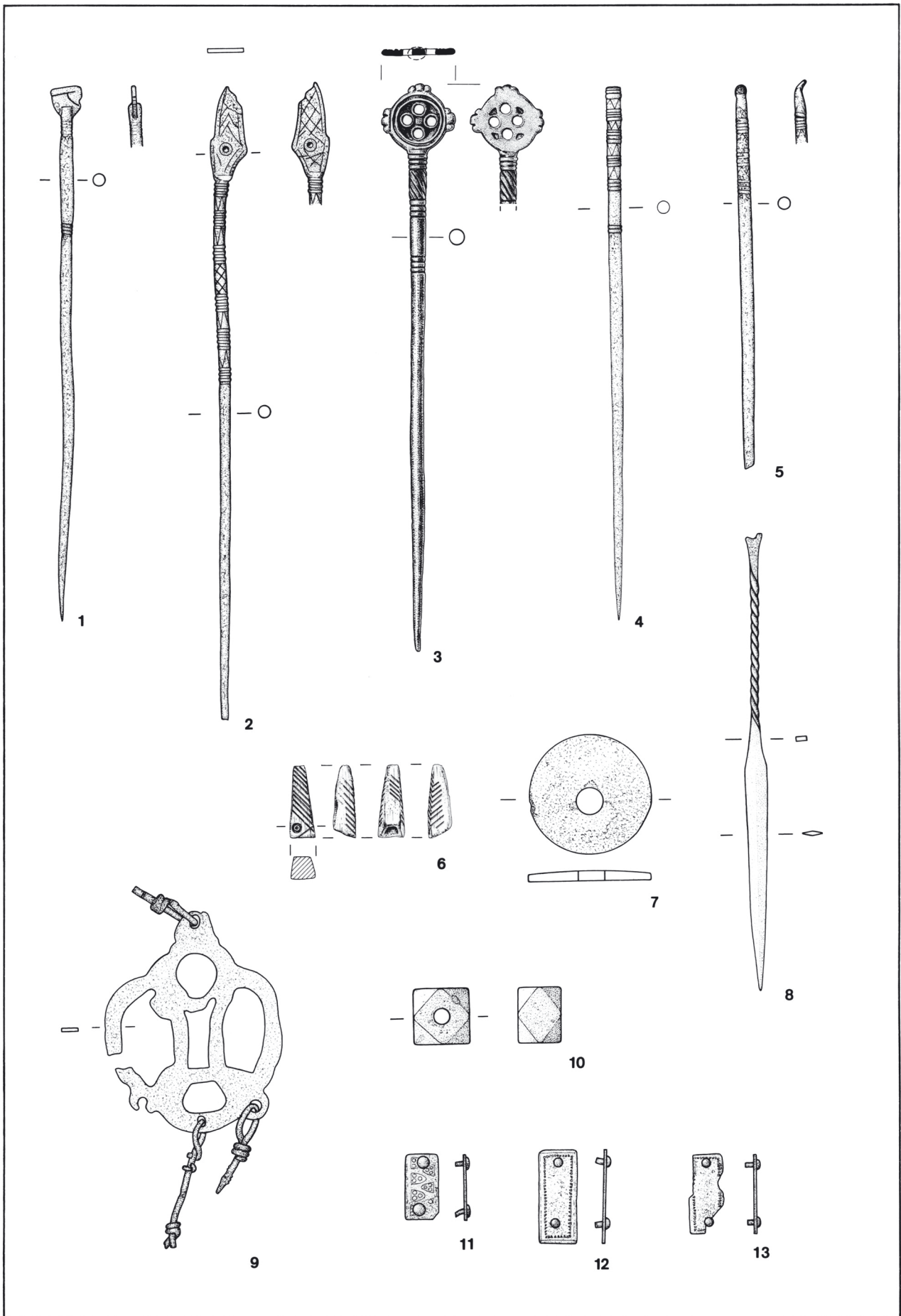

Sindelfingen (Fst. 1). Frauenschmuck und Anhänger. 1-5 F 84/22, 1-5; 6-13 F 84/24, 3-8. M 2:3.

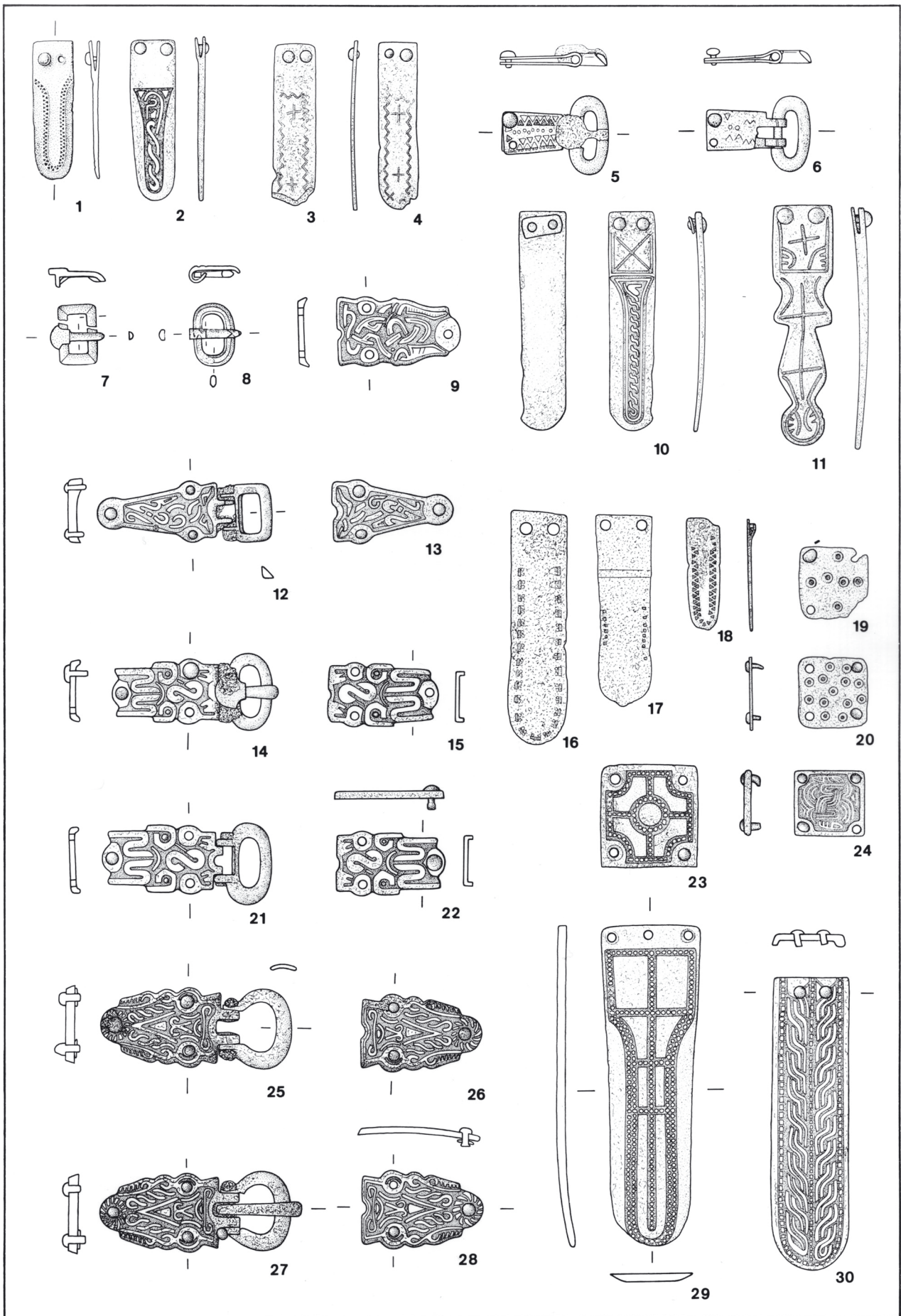

Sindelfingen (Fst. 1). Riemenzungen, Schnallen, Teile von Wadenbinden und Schuhgarnituren.
 2-6.9.12-15.19-30 F 84/25, 1-11; 1.10.11.16.-18 F 84/26, 1-6; 7.8 F 84/27, 1.2. M 2:3.

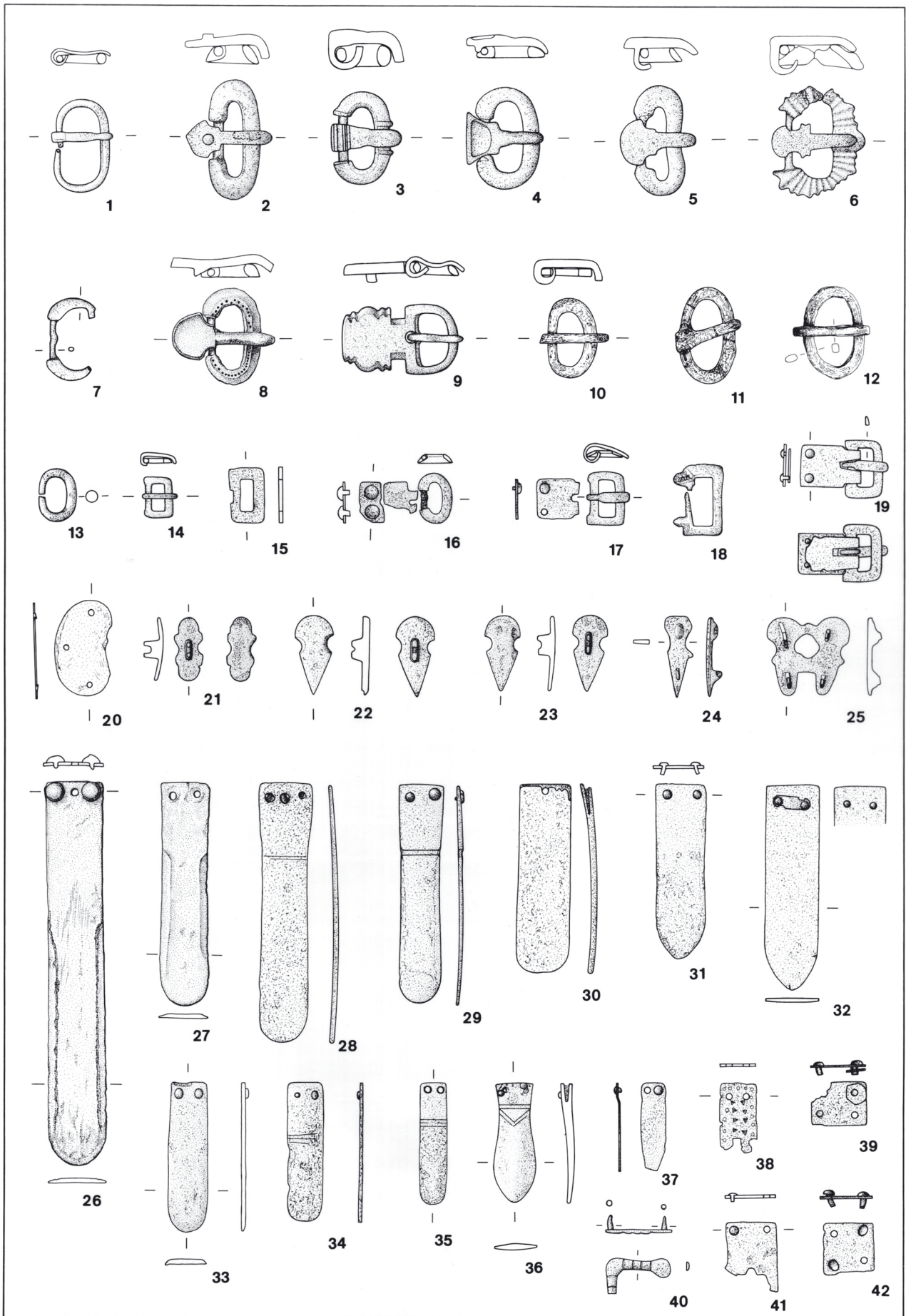

Sindelfingen (Fst. 1). Schnallen, Riemenzungen und Beschläge. 1-19 F 84/27,3-21; 20-25.38-42 F 84/28,1-11; 26-37 F 84/26,7-18. M 1:2.

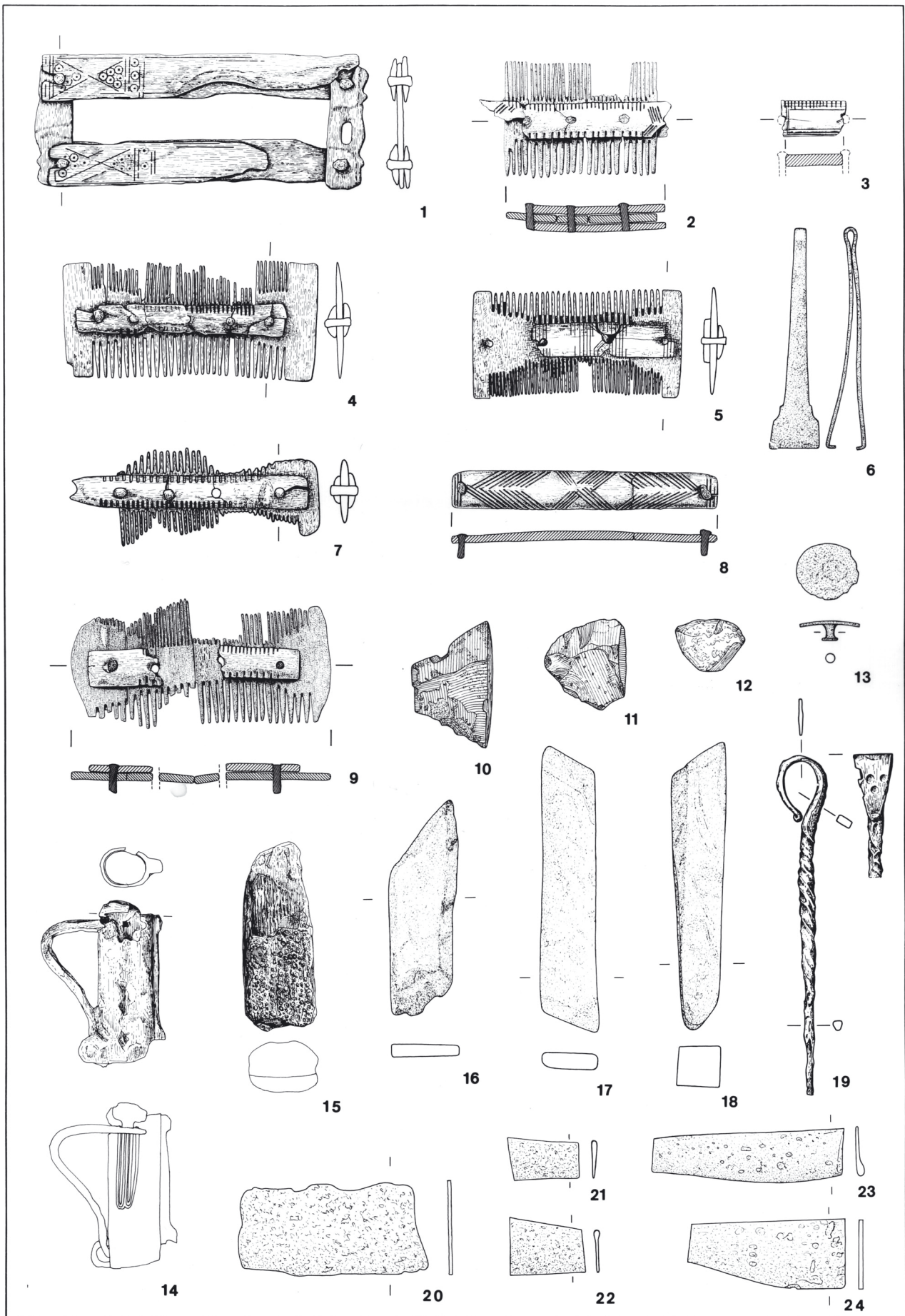

Sindelfingen (Fst. 1). Käämme, verschiedene Geräte, Flachglas. 1-5.7-9 F 84/29,4-11;
6 F 84/29,12; 10-19 F 84/29,13-17.19; 20-24 F 84/33,5. M 1:2.

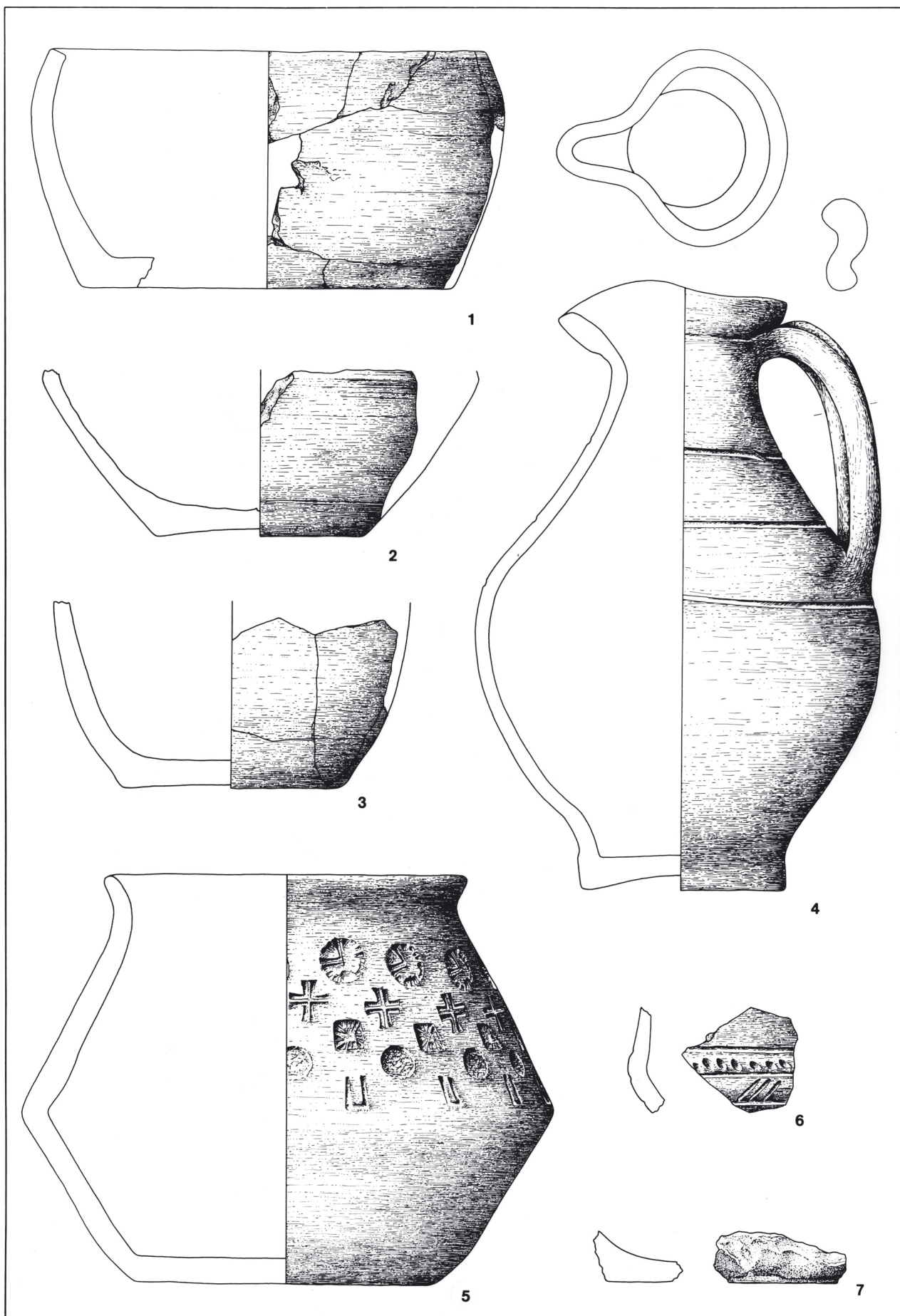

Sindelfingen (Fst. 1). Keramik F 84/32,4-6.9.11.12. M 1:2.

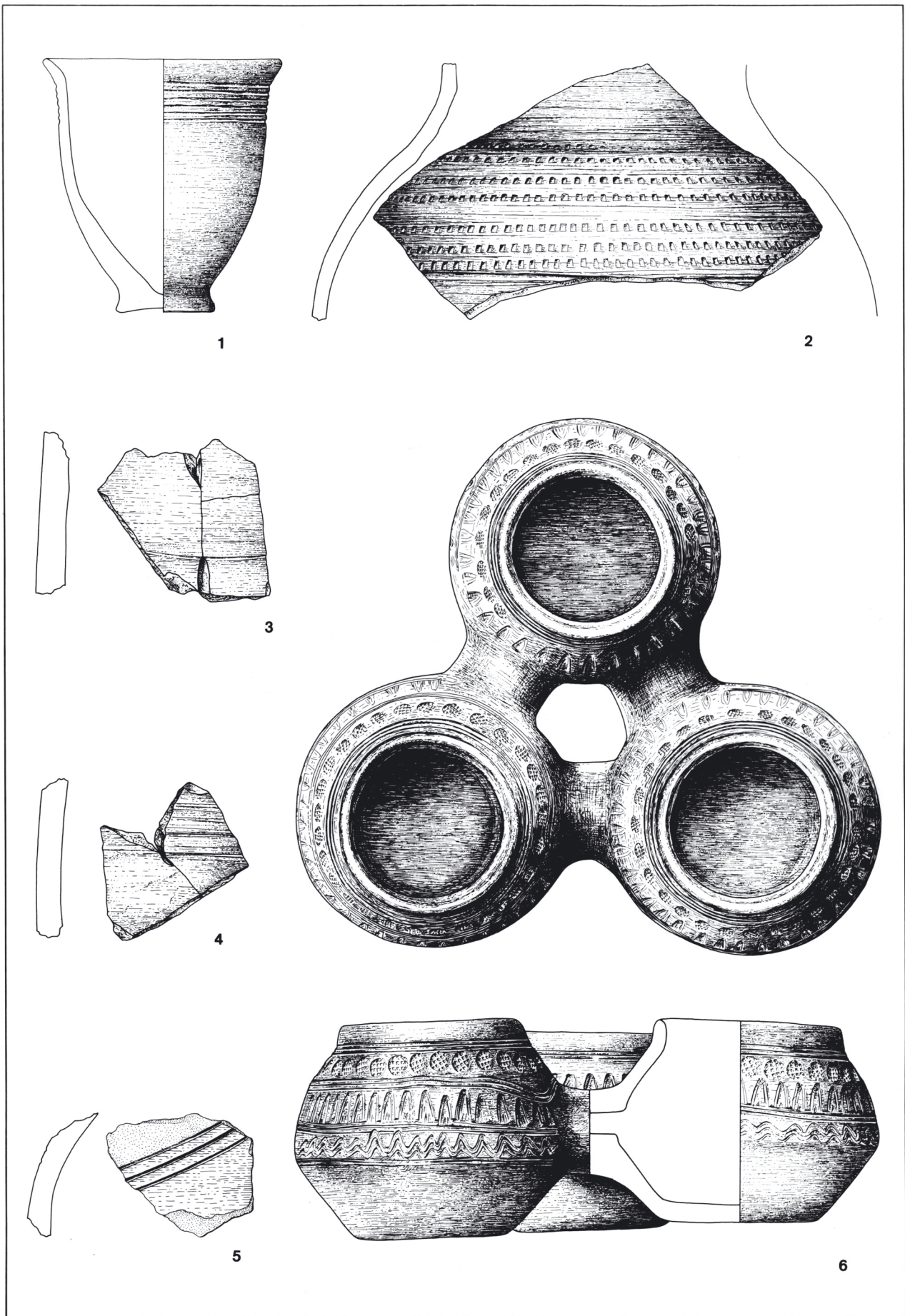

Sindelfingen (Fst. 1). Keramik F 84/32,7.9.10.13-15. M 1:2.

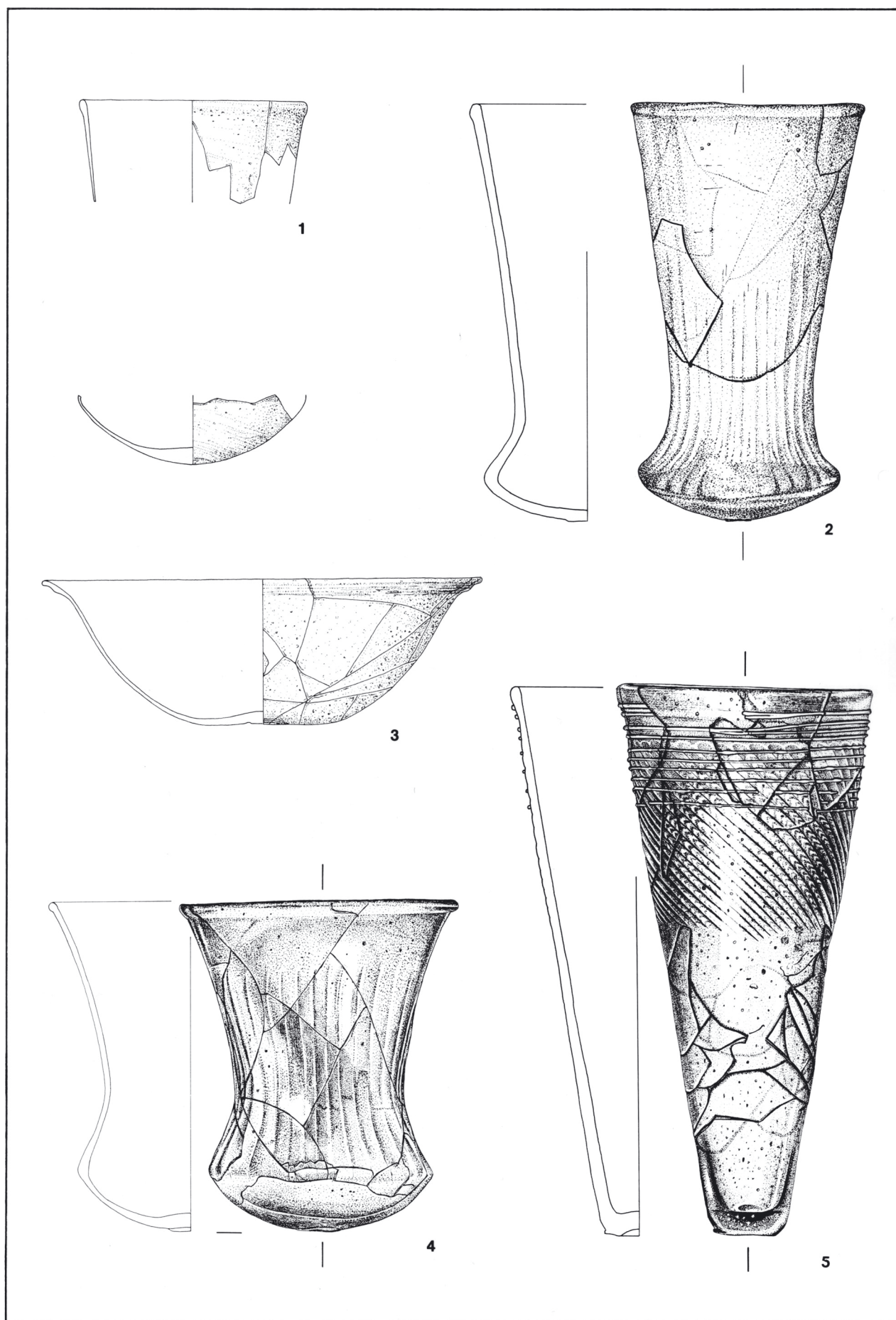

Sindelfingen (Fst. 1). Glas F 84/33,1-5. M 2:3.

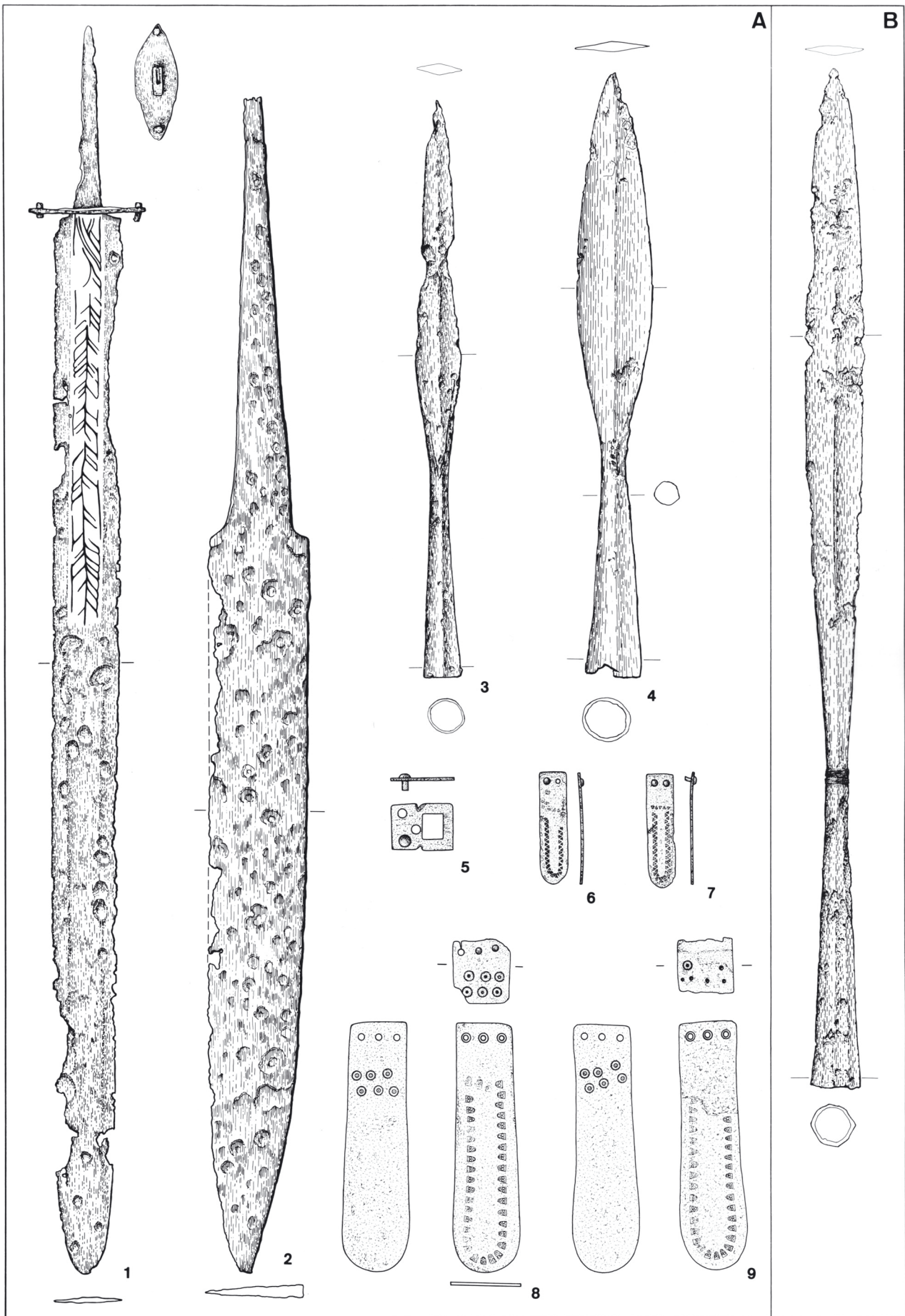

Sindelfingen (Fst. 2). A 1909/A 115; B 1951/51/132. A 1 M 1:4; A 2-4, B M 1:3; A 5-9 M 1:2.

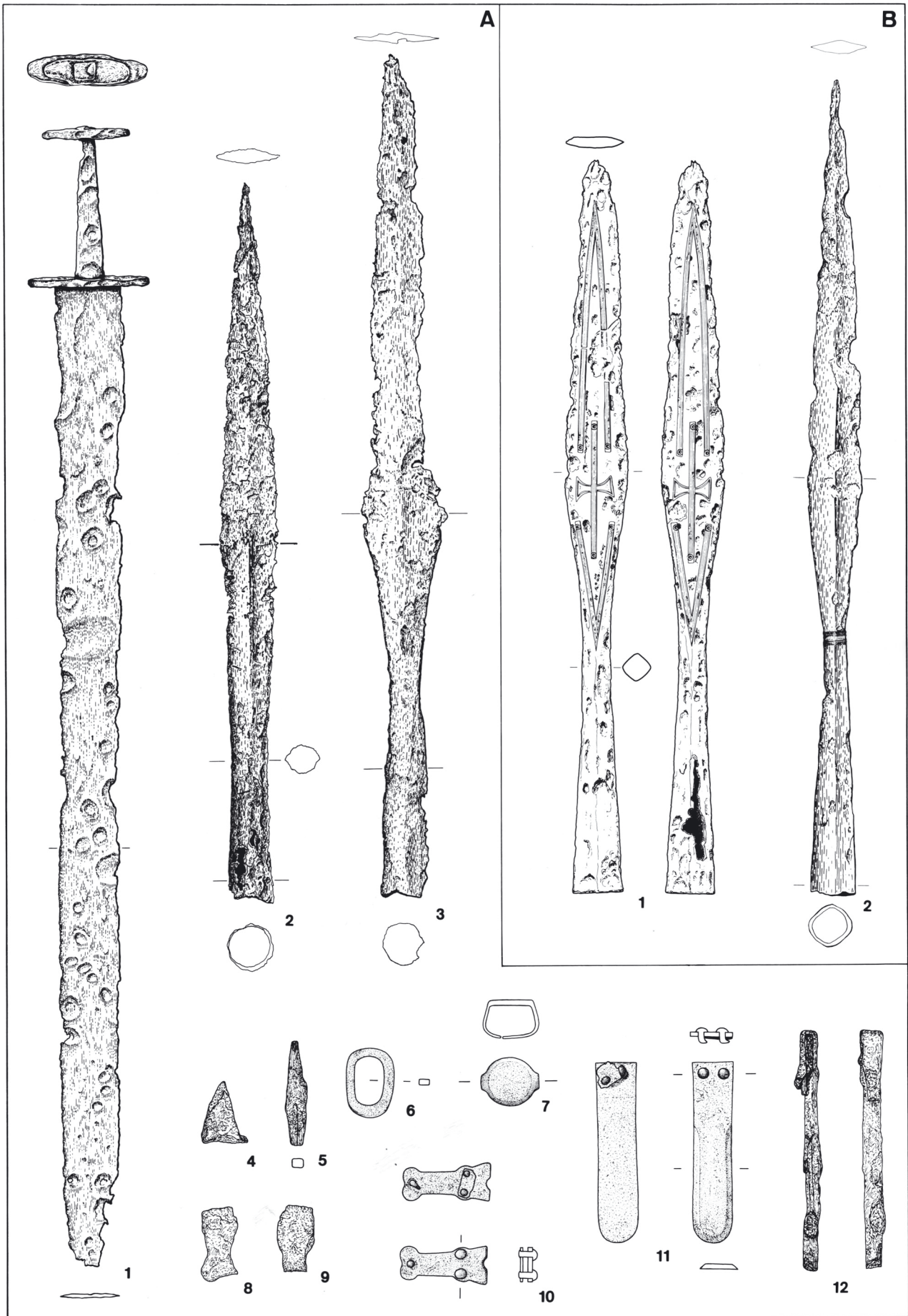

Sindelfingen (Fst. 2). A 1937/37/135; B 1910/A 150. A 1 M 1:4; A 2.3, B 1.2 M 1:3;
A 4-12 M 1:2.

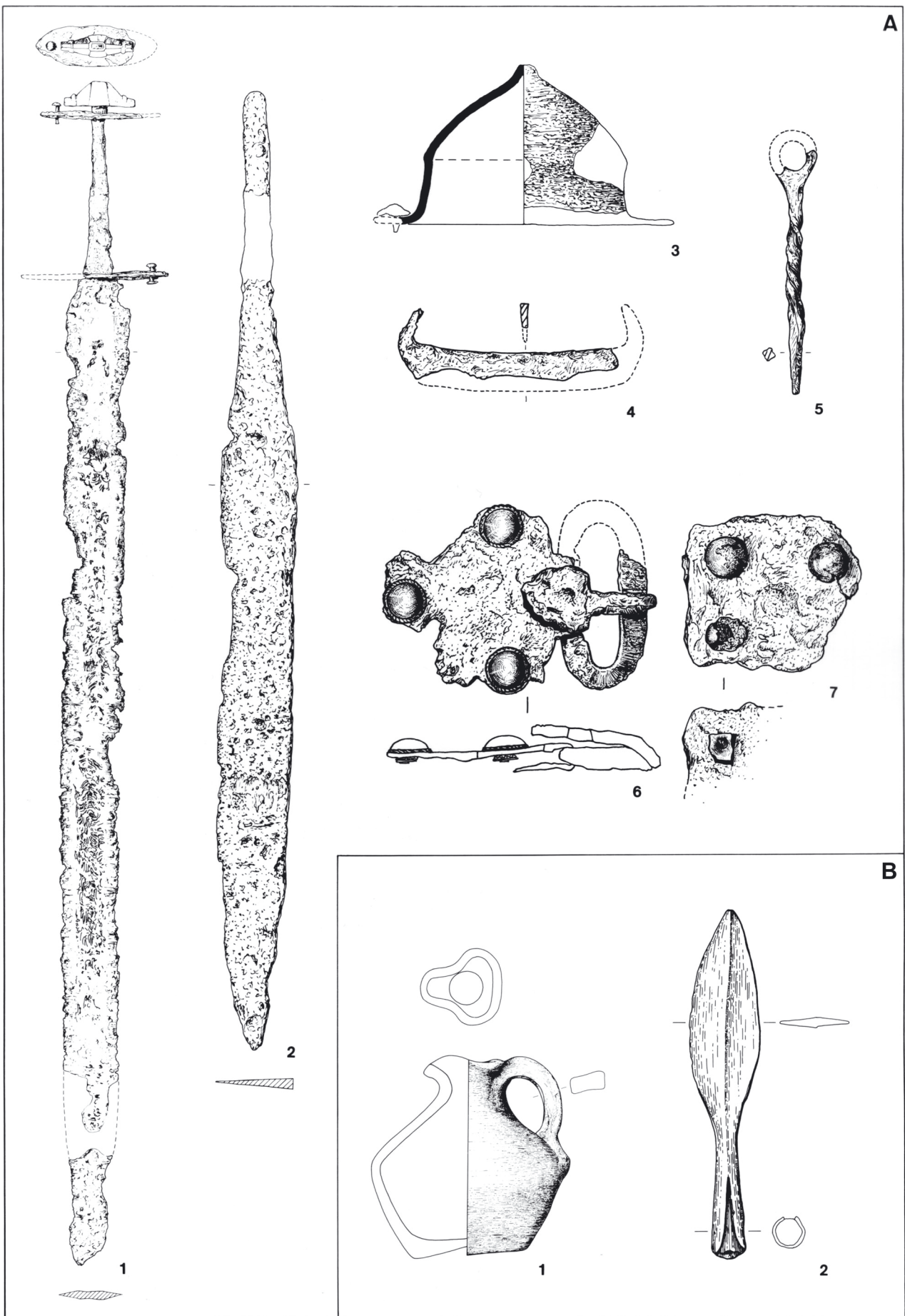

Sindelfingen (Fst. 1). A 1967/Grab 1; B 1956/Grab 1. A 1 M 1:4; A 2.3, B 1 M 1:3;
A 4-7, B 2 M 1:2.

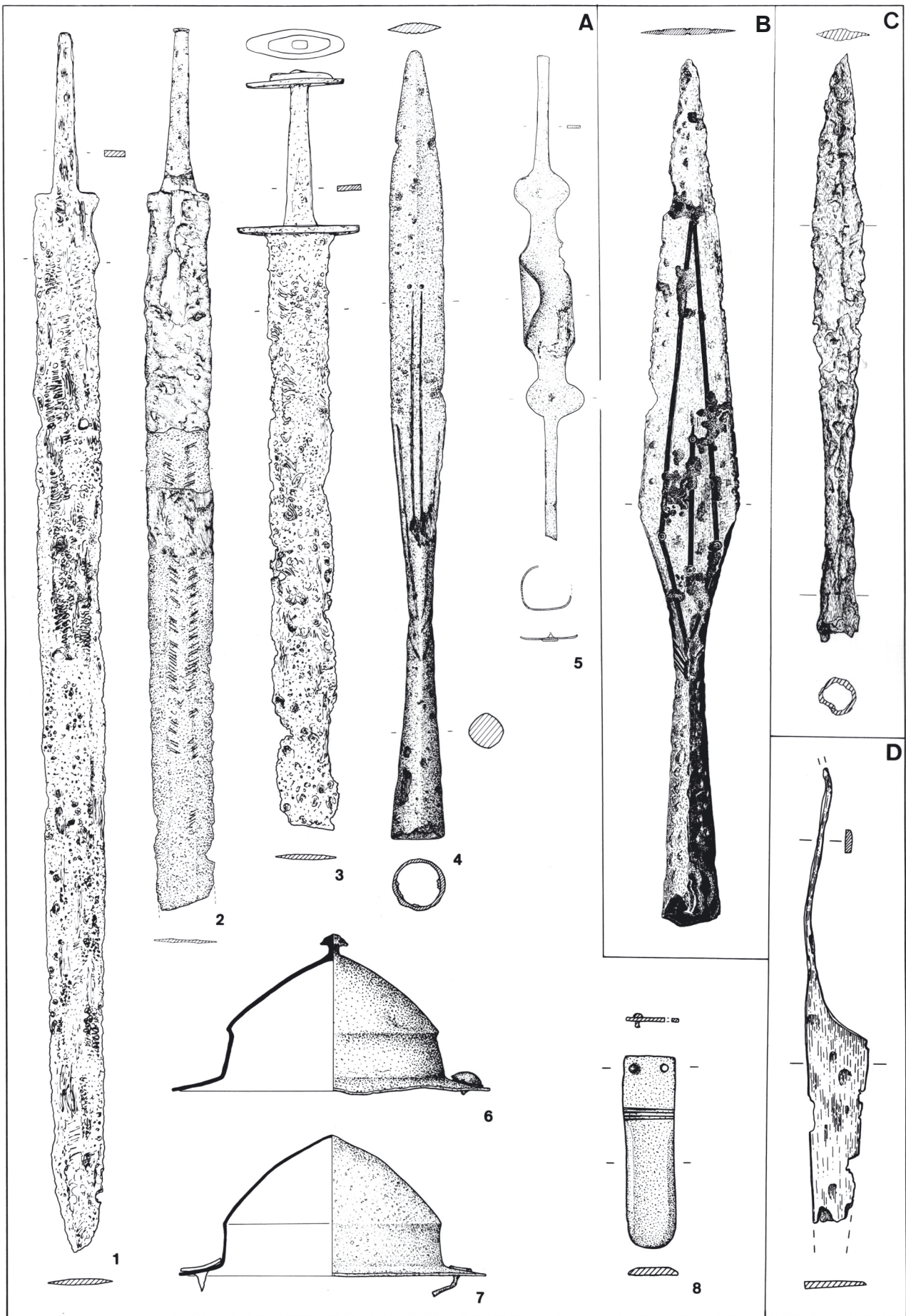

Sindelfingen (Fst. 2). A 1975; (Fst. 3) B 1961; (Fst. 4a) C; (Fst. 4b) D. A 1-3.5 M 1:4;
 A 4.6.7, B, C M 1:3; A 8, D M 1:2.



Deufringen (Fst. 1,1) 1. Aidlingen (Fst. 1,2,3) 2-4. Dagersheim (Fst. 2) 1967/Grab 1 5.6; (Fst. 1) 1897/Grab7. 1 M 1:4; 2.3 M 1:3; 4-7 M 1:2.

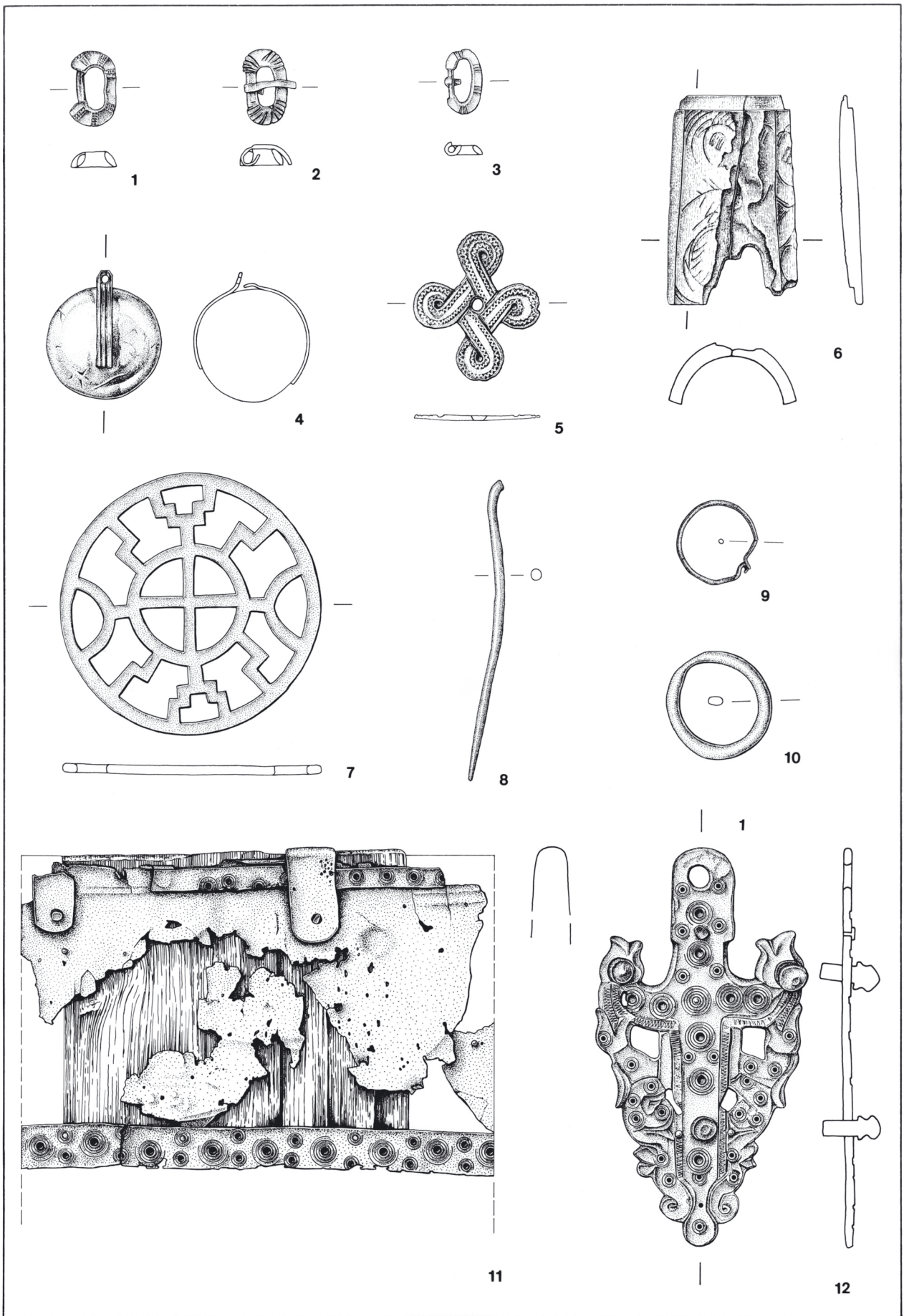

Dagersheim (Fst. 1). 1897/Grab. M 2:3.

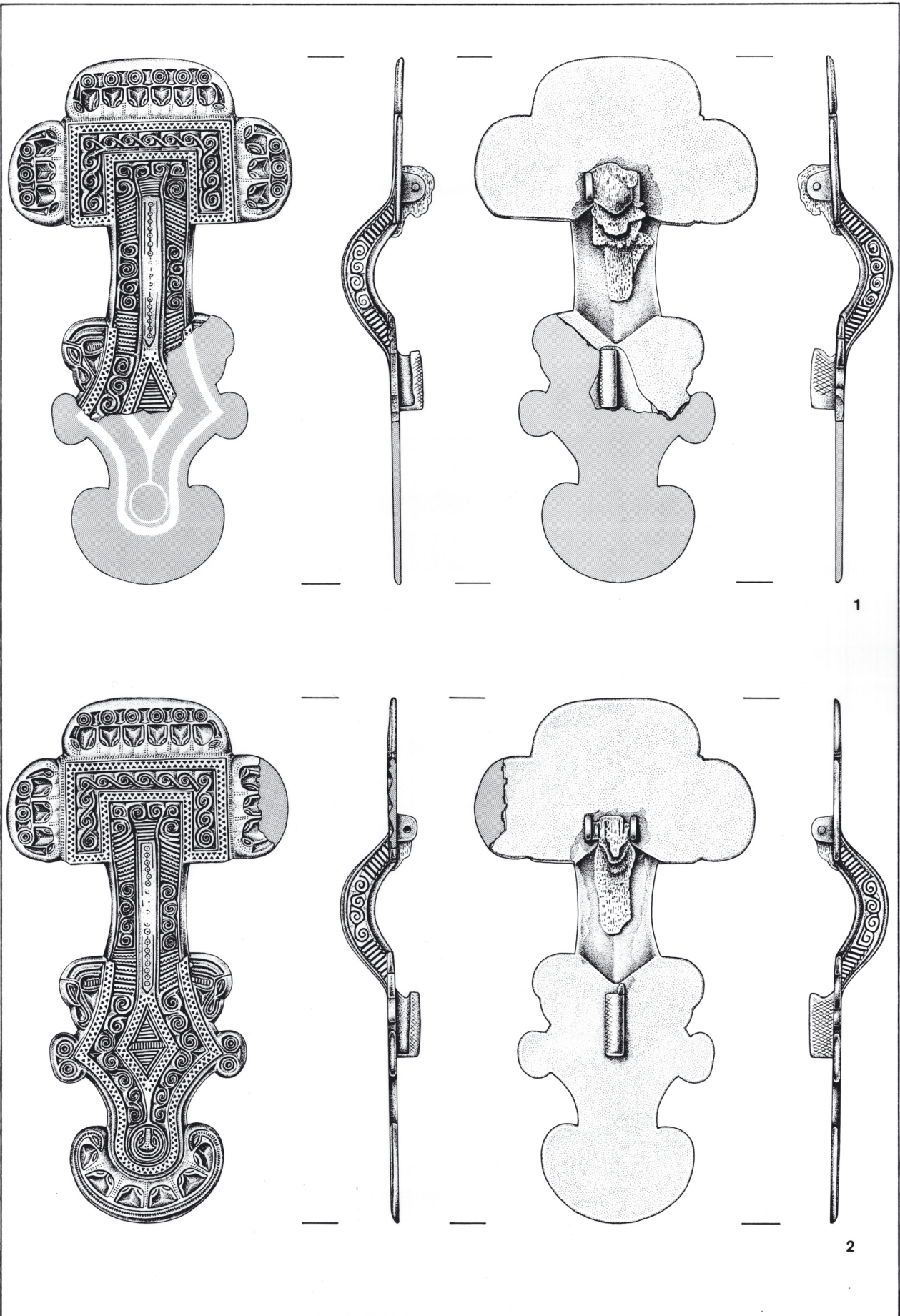

Dagersheim (Fst. 1). 1897/Grab. M 2:3.

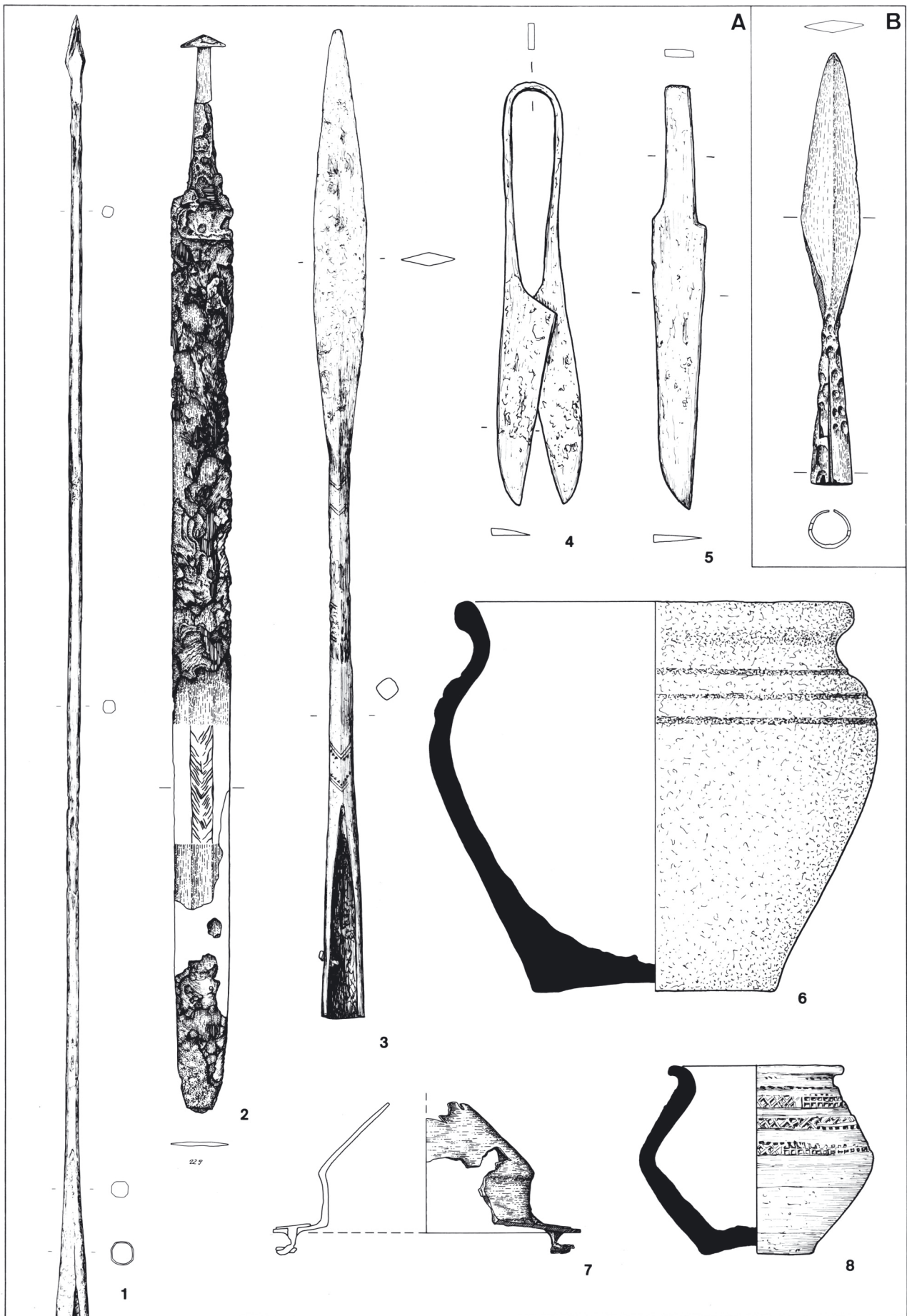

Dagersheim (Fst. 2) A 1968/Grab 4; (Fst. 4) B. A 1.2 M 1:4; A 3.7, B M 1:3; 4-6.8 M 1:2.

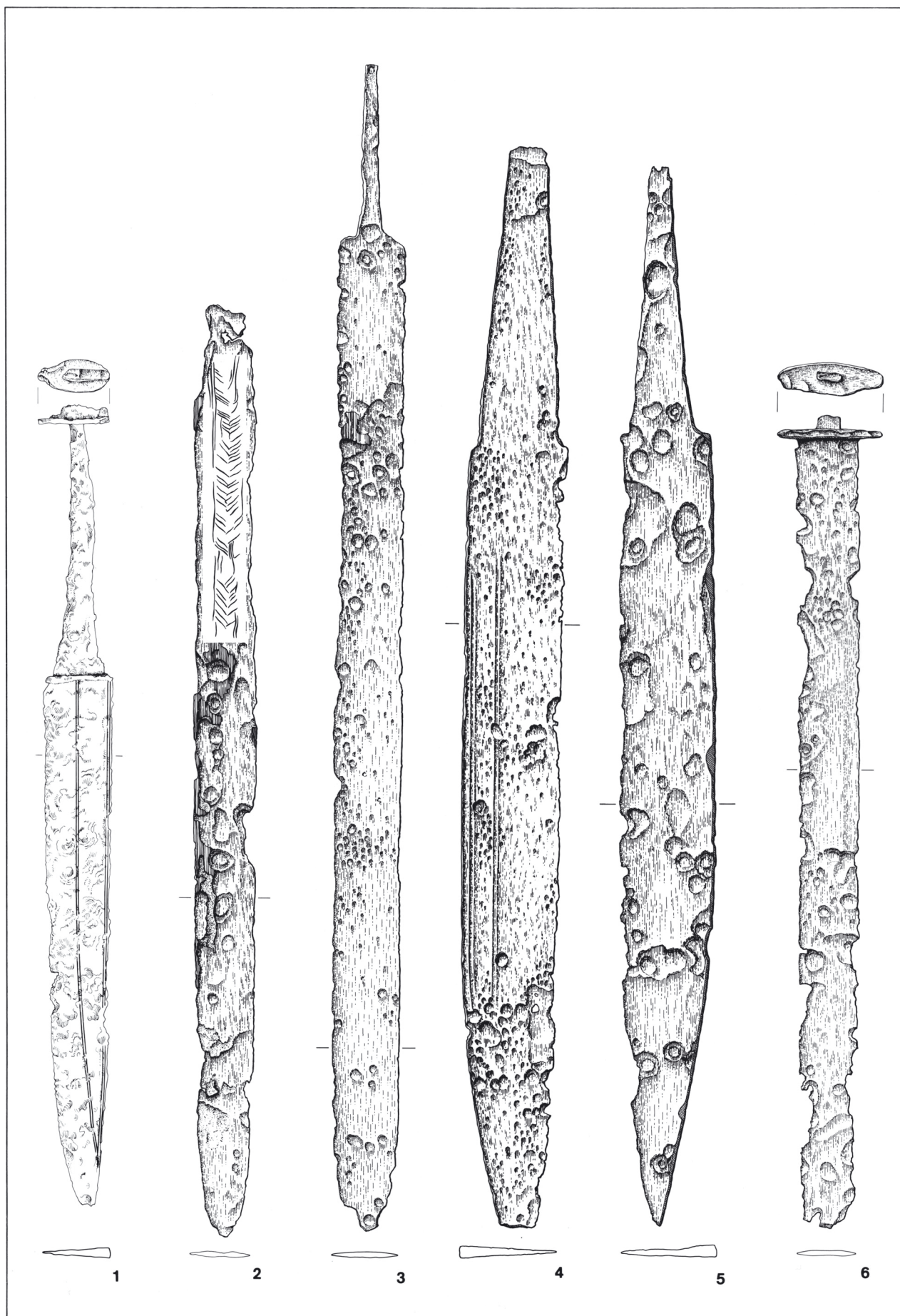

Dachtel 1. Ehningen (Fst. 1) 2-6. 1.4.5 M 1:3; 2.3.6 M 1:4.

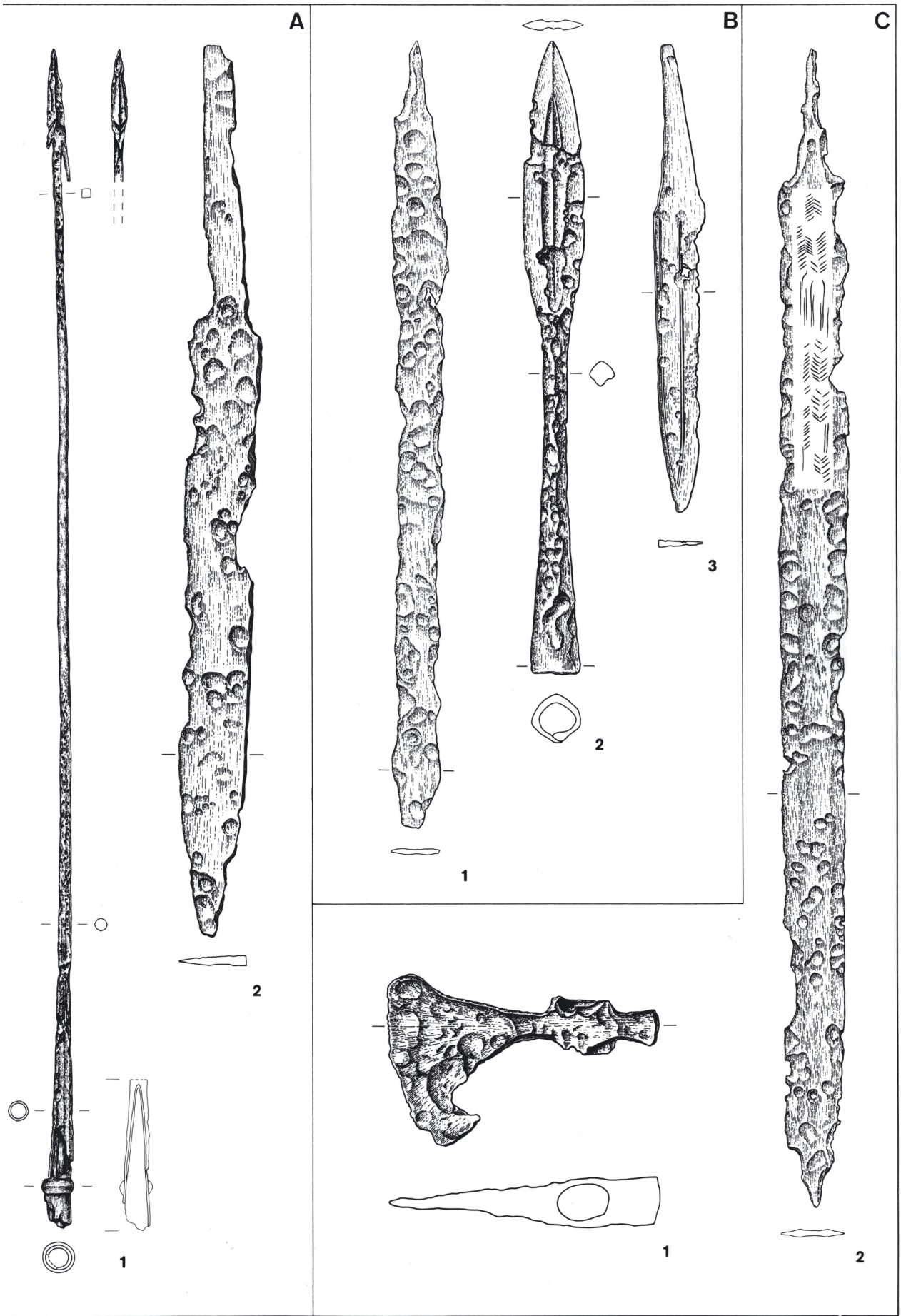

Ehningen (Fst. 1). A Grab 3; B Grab 1; C Grab 7. A 1, B 1, C 2 M 1:4; A2, B 2.3, C 1 M 1:3.

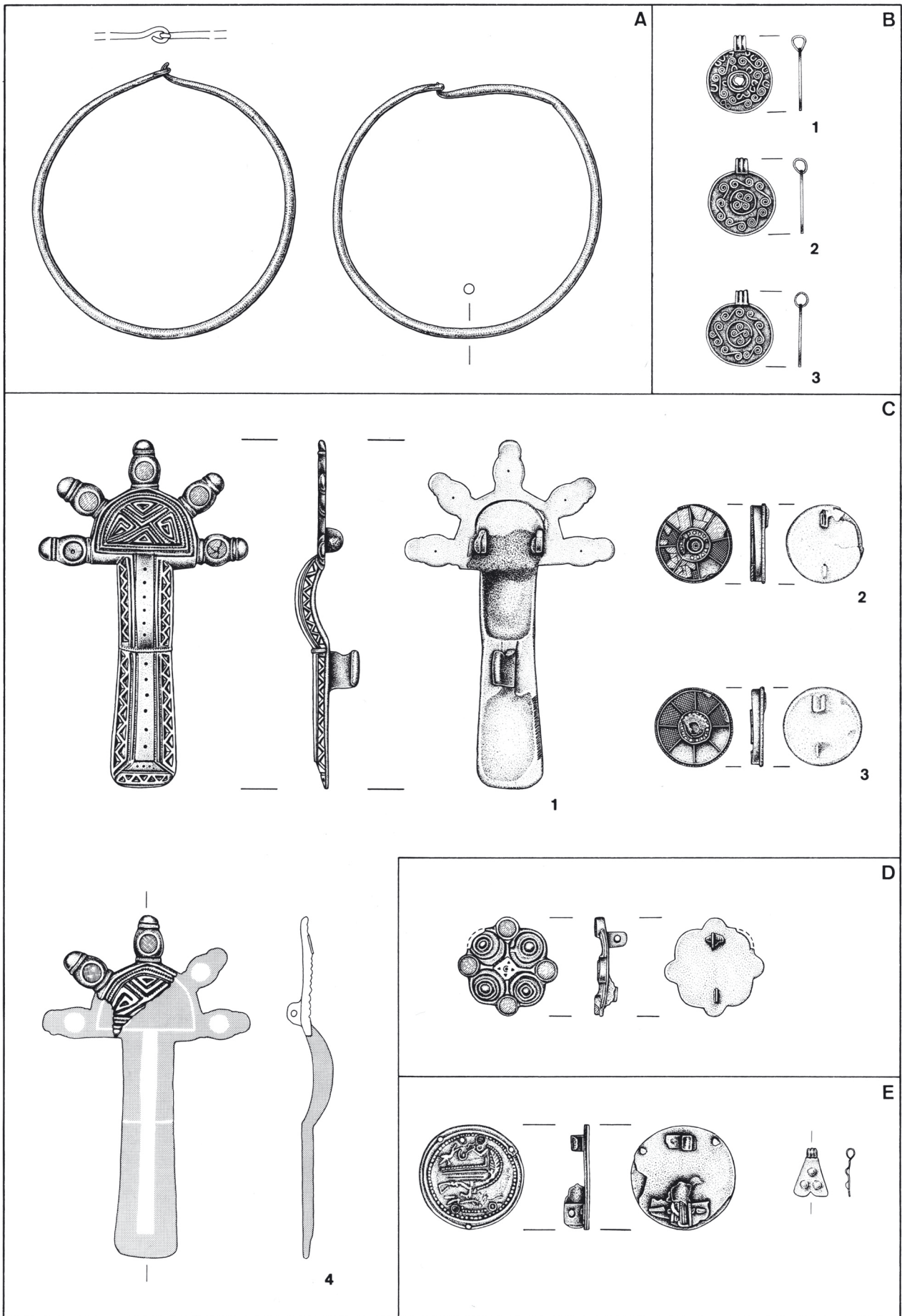

Ehningen (Fst. 1) A 510; B Grab 4; C Grab 12; D Grab 10. Darmsheim E 1957/Grab 2. M 2:3.

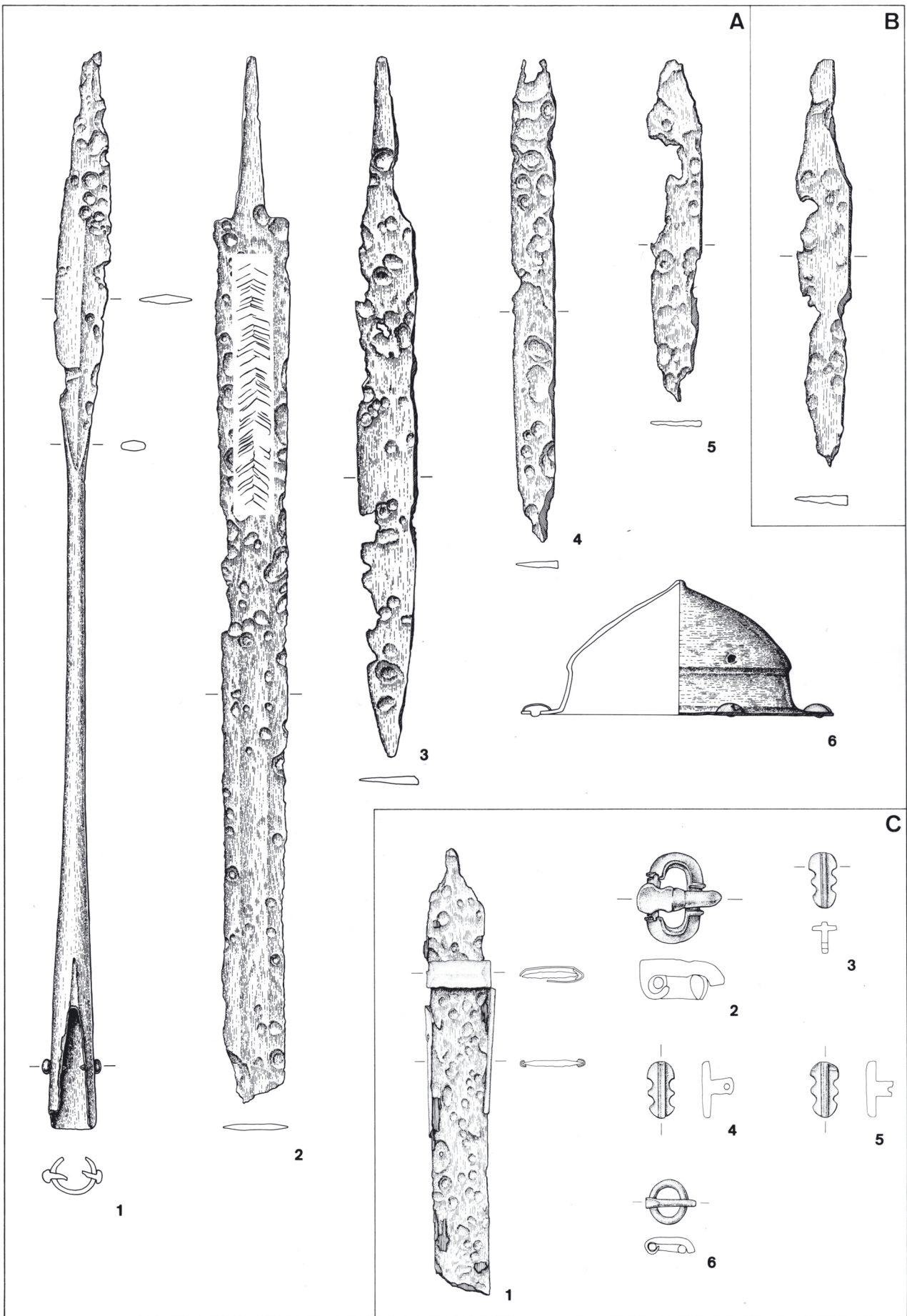

Ehningen (Fst. 1). A Grab 13; B Grab 14; C Grab 10. A 1.3-6 M 1:3, A 2, C 1 M 1:4; B, C 2-6 M 1:2.

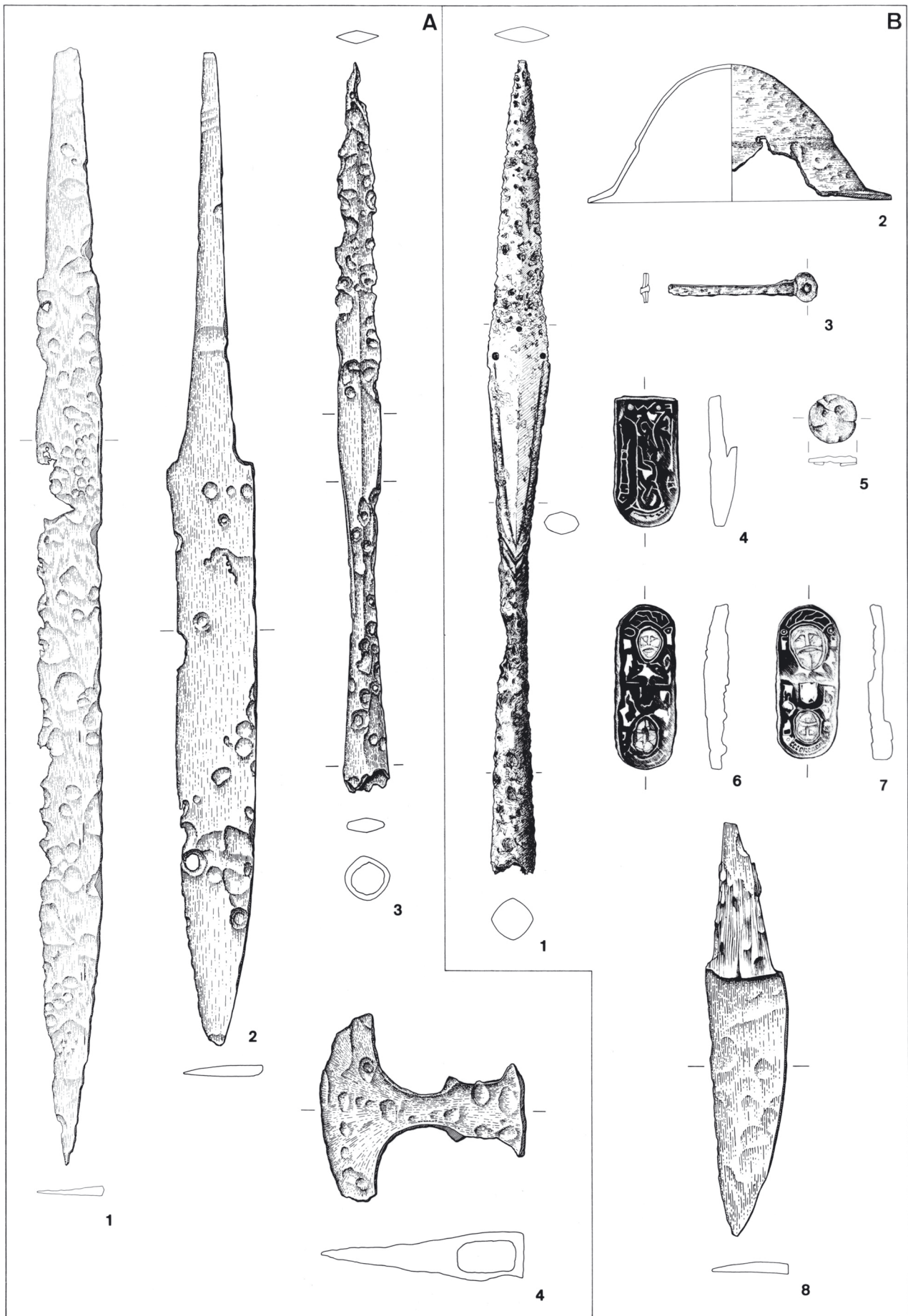

Ehningen (Fst. 1) A 1021 1; A.V. III 154 2; A 354 3; Grab 11 4. Kuppingen (Fst. 3) B 1-7;
 (Fst. 4) 8. A 1 M 1:4; A 2-4, B 1-3 M 1:3; B 4-8 M 1:2.

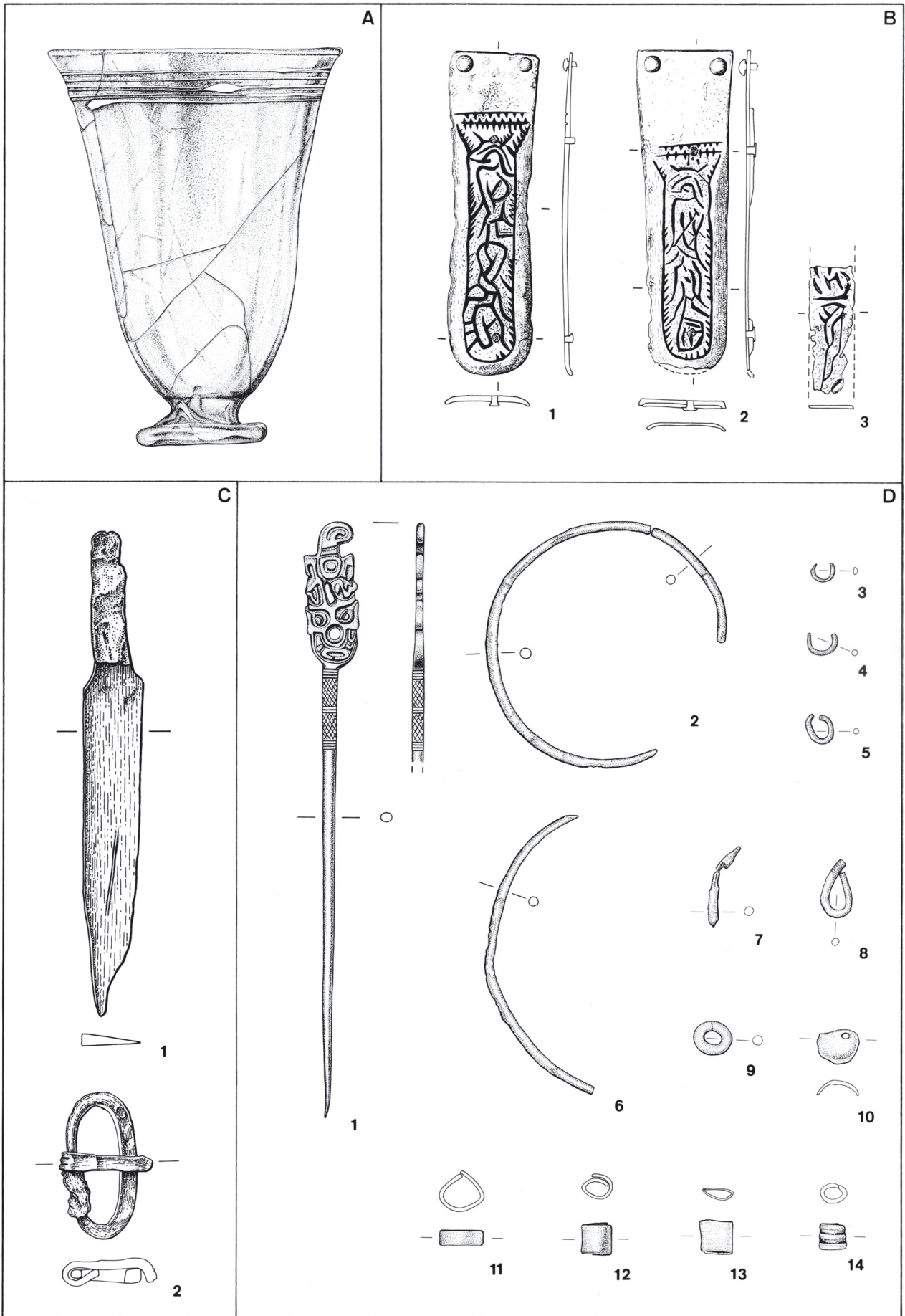

Ehningen (Fst. 1) A 8821; (Fst. 2) C. Kuppigen (Fst. 2) B. Oberjesingen D. M 2:3.

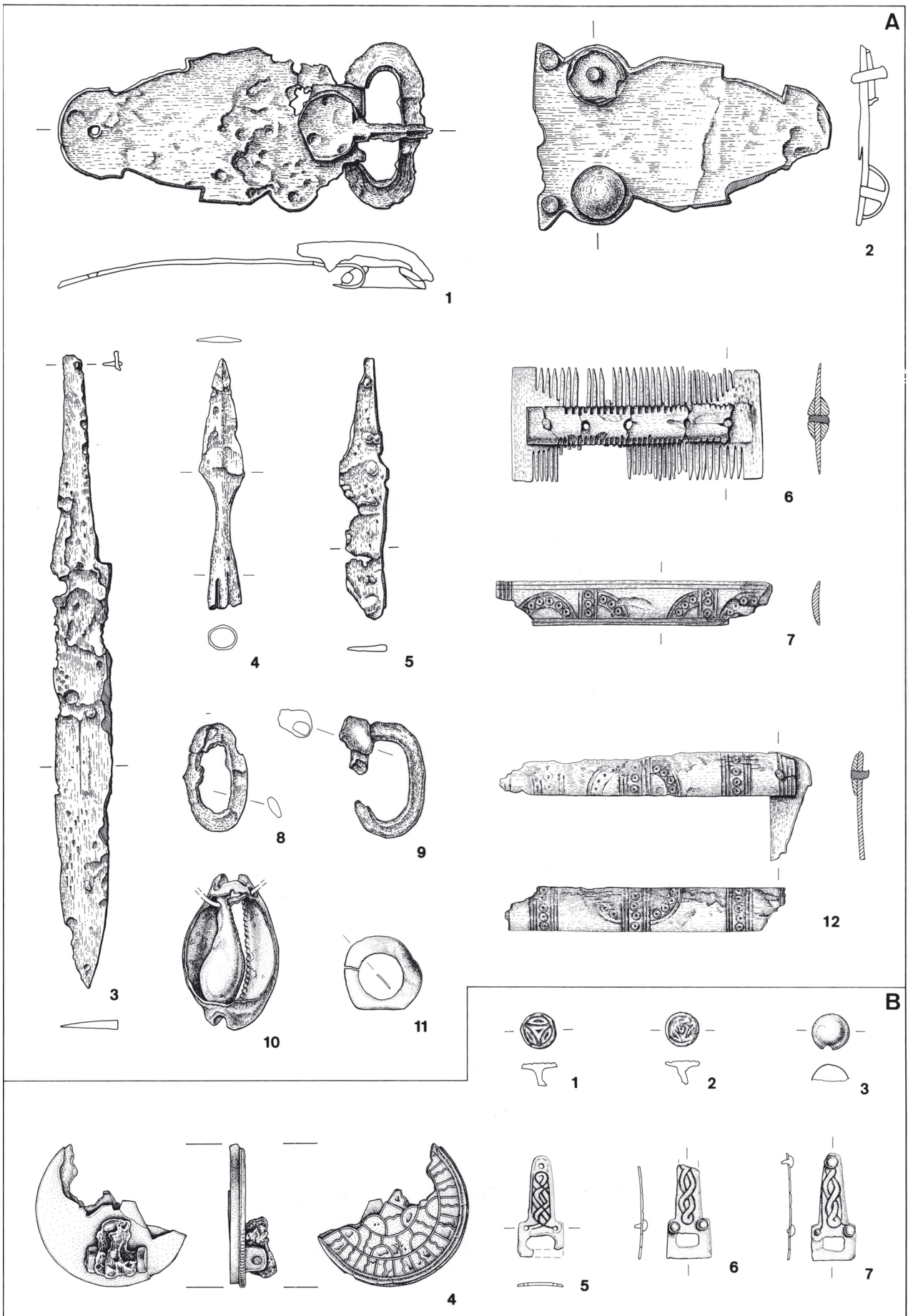

Gärtringen A. Magstadt B. M 1:2; A 3 M 1:3.

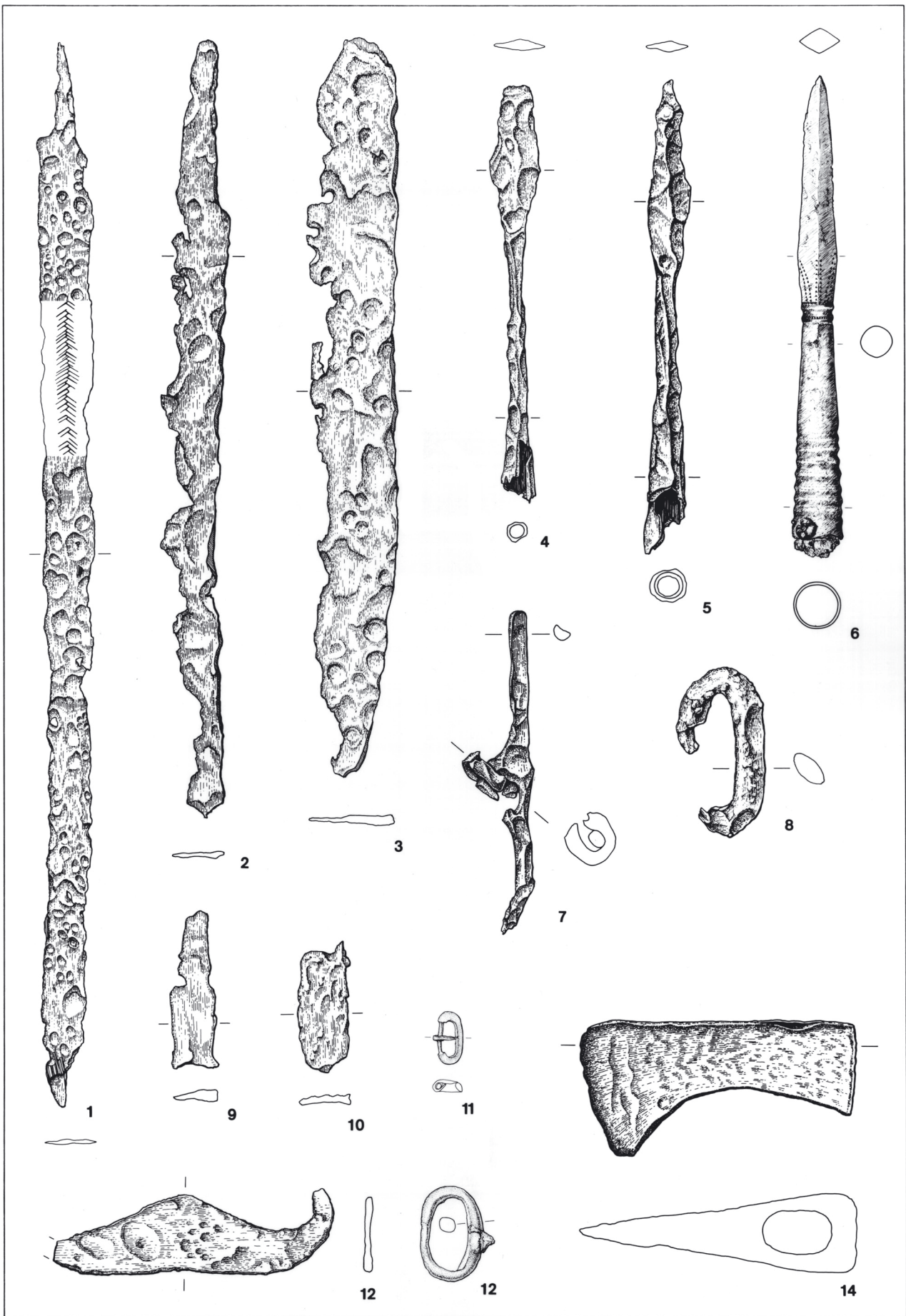

Magstadt. 1 M 1:4; 2-6.14 M 1:3; 7-13 M 1:2.

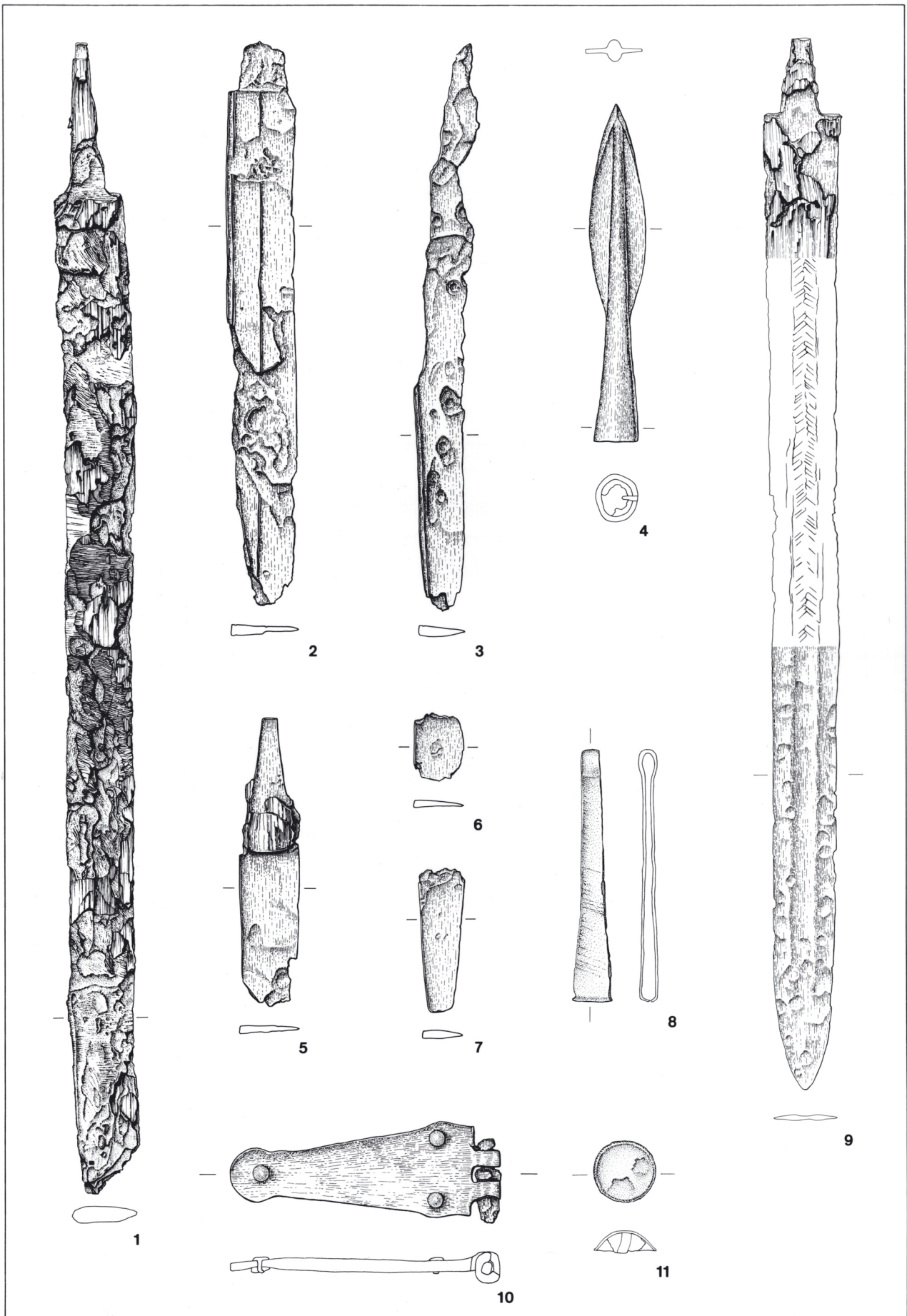

Magstadt. 1958 1-9; 1980/Grab 1.9 M 1:4; 2-7 M 1:3, 8.10.11 M 1:2.

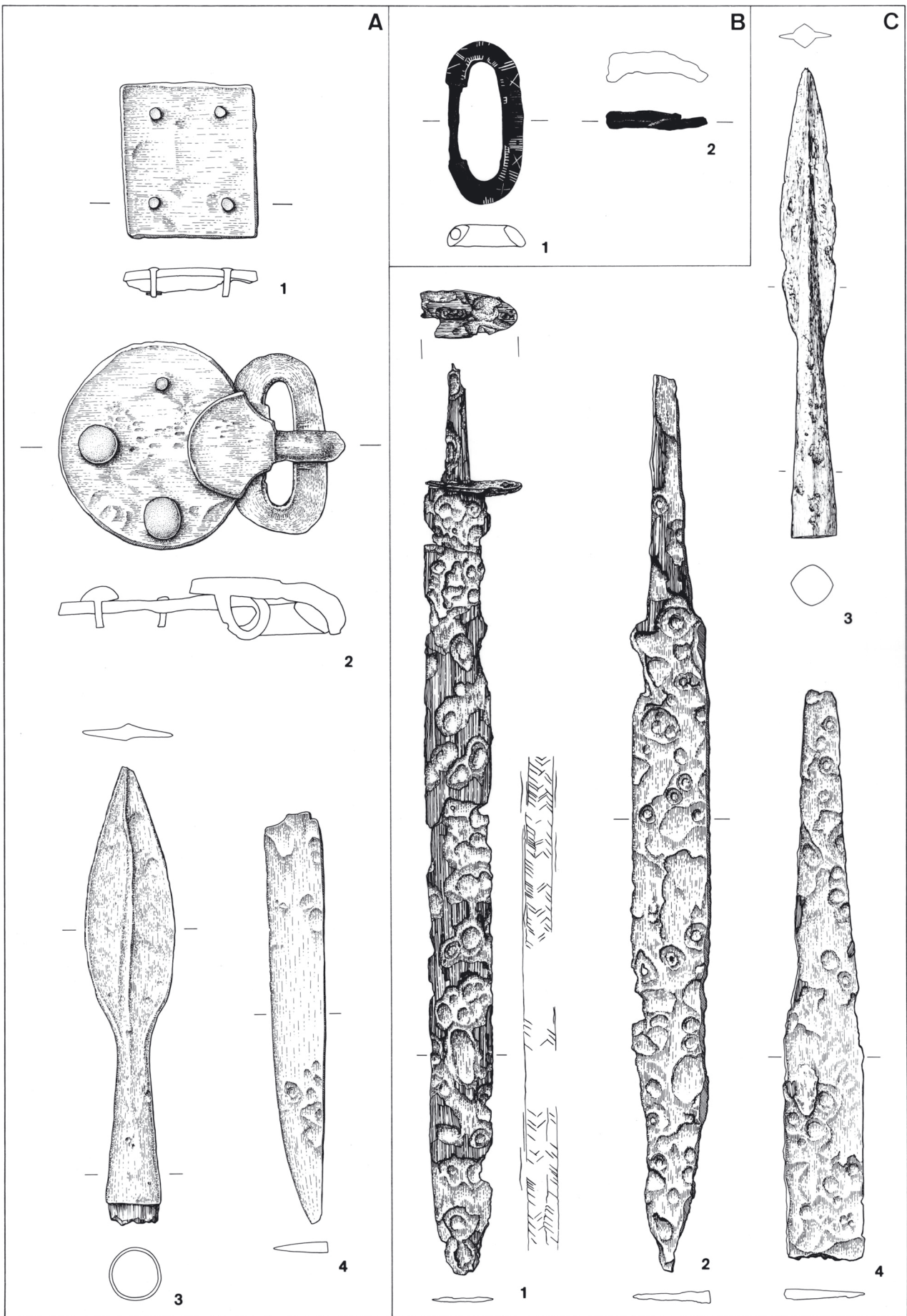

Magstadt A 1980/Grab. Merklings B. Nufringen C. A 1.2, B M 1:2; A 3.4., C 2-4 M 1:3;
C 1 M 1:4.

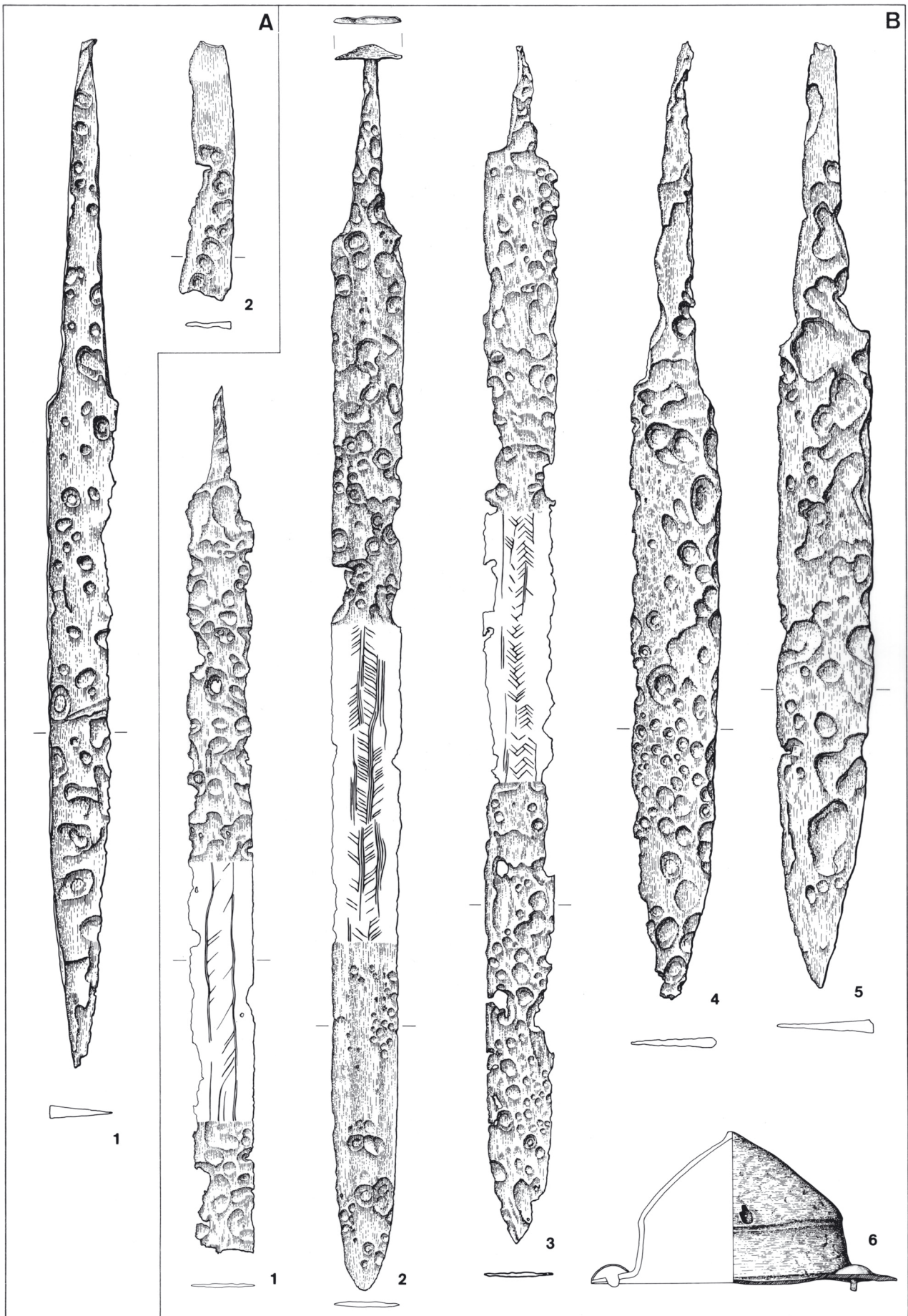

Malsheim A. Darmsheim B. A 1, B 4-6 M 1:3; A 2 M 1:2; B 1-3 M 1:4.

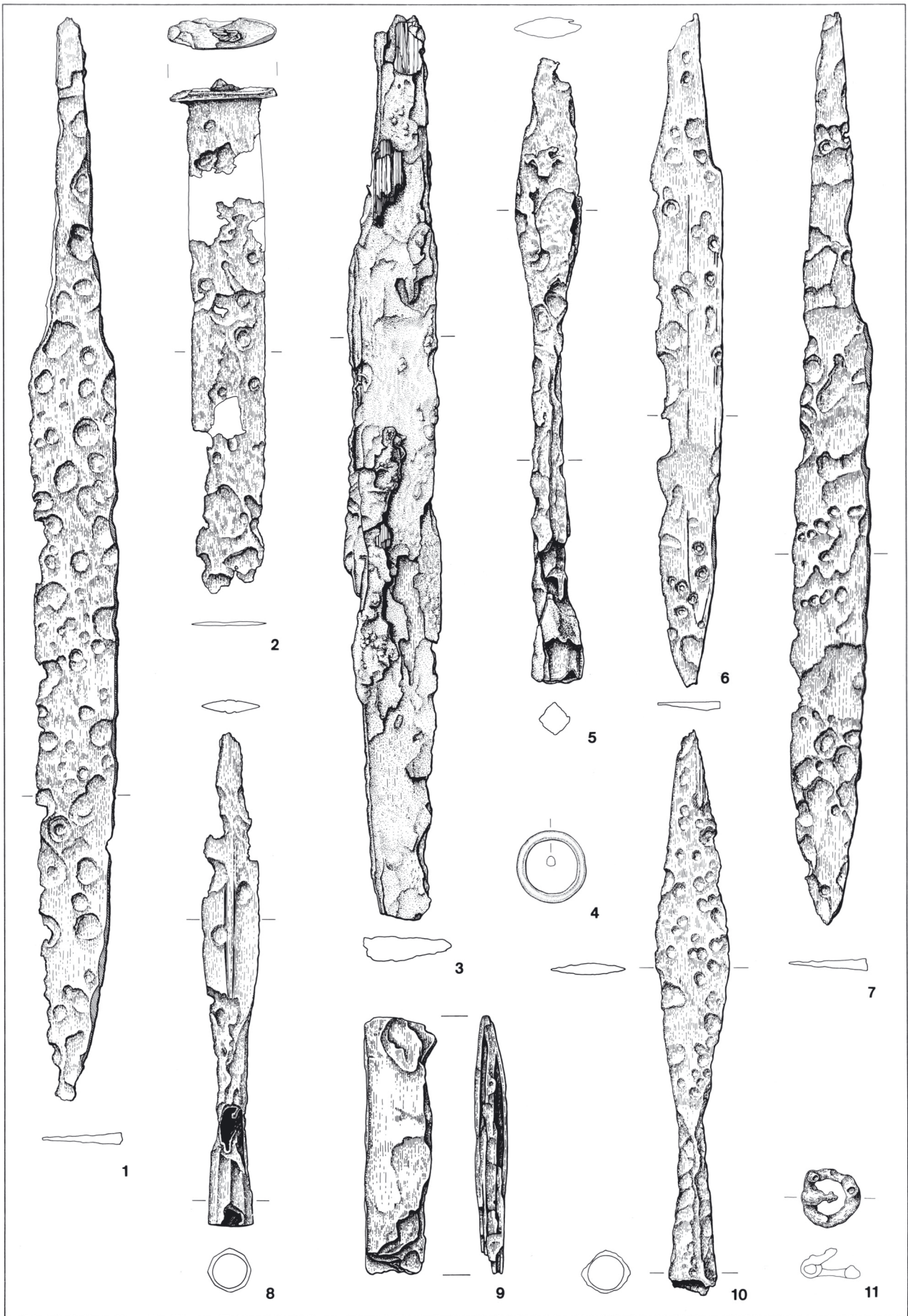

Darmsheim 2798 1.2.8; 1952/Grab 3-5; 1951/Grab 1 11; 1957/Grab 1 9;
 1966 6.7.10. 1.3.5-8.10 M 1:3; 2 M 1:4; 4.9.11 M 1:2.

A



B



Sindelfingen (Fst. 1). Glasperlen. A 1 10499; 2 8538/8539; 3 10743. B 1.2.6 F 84/23,21a-c; 3 F 84/23,2; 4.5 F 84/23,21e.f. M ca. 1:3.

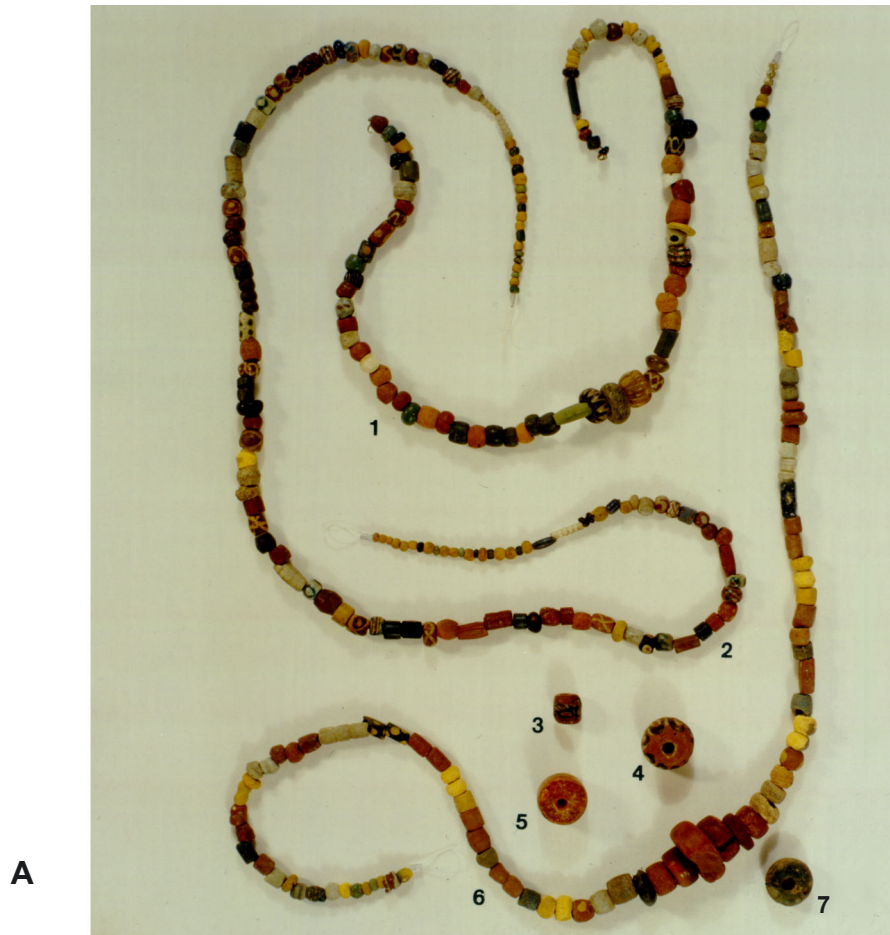

A



B

Sindelfingen (Fst. 1). Glasperlen. A 1 F 84/23,5; 2 F 84/23,3; 3-5 F 84/23,21d.g.m; 6 F 84/23,11; 7 F 84/23,21h. B 1 F 84/23,6; 2-4 F 84/23,21i; 5 F 84/23,10; 6 F 84/23,9. M ca. 1:3.



A



B

Sindelfingen (Fst. 1). Glasperlen. A 1 F 84/23,4; 2 8670; 3 F 84/23,7; 4 F 84/23,8; 5 F 84/23; 6 F 84/23,21h; 7 8820. M ca. 1:3. B F 84/23,14*.



Sindelfingen. Glasperlen. 1 (Fst. 2) 1909/A 115,5; 2 (Fst. 1) F 84/23,13. M ca. 2:3.

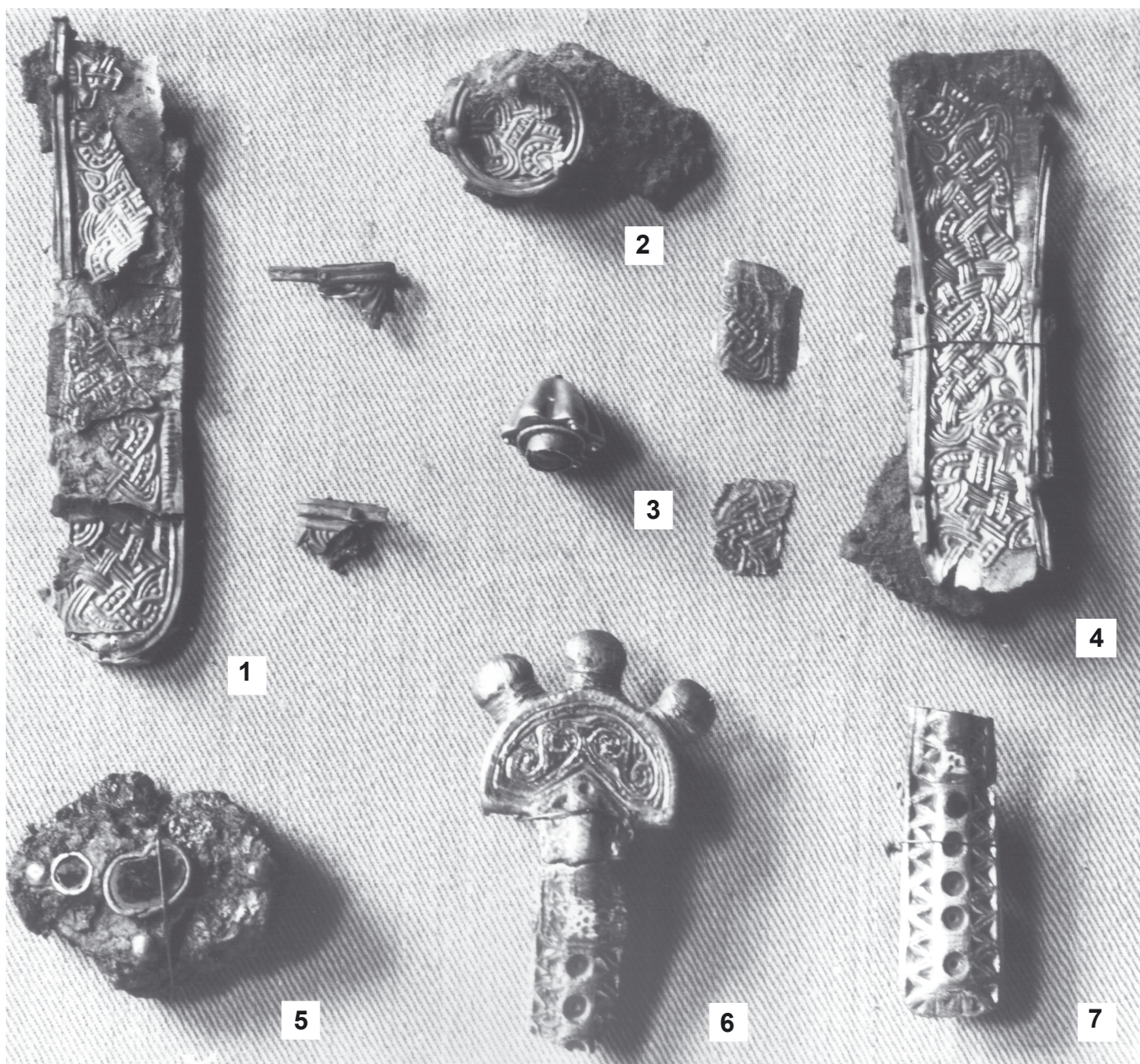

Sindelfingen (Fst. 1). Verschollene Objekte. 1.2.4 8794,1; 3 8820,5; 5 10670,5;
6.7 F 84/19,13.



1



2



3



4



6



7

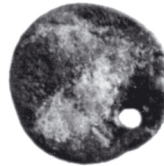

5

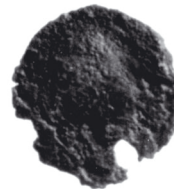
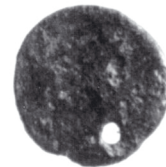

8



Sindelfingen (Fst. 1). Silberschnallen 1.2 10670,20.21; Armring 3 F 84/20,2;
Münzen 4.5.8 F 84/31,1-3; Wadenbindenriemenzungen 6.7 8820,11. M ca. 2:3.



1



2

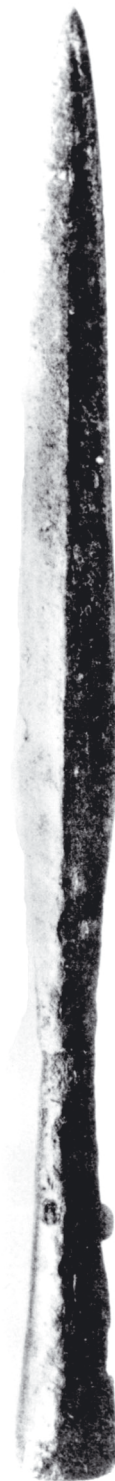

3



1

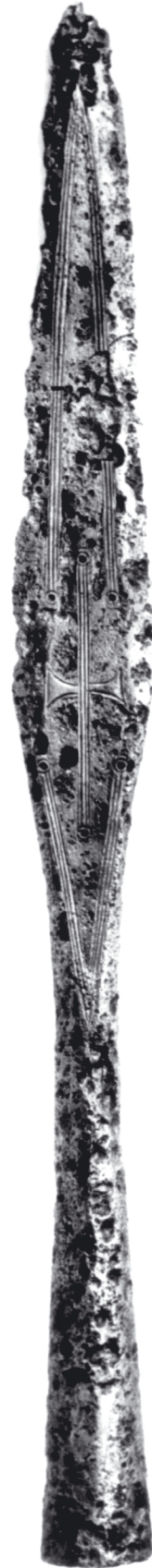

2

Sindelfingen. (Fst. 1) 1 Goldgriffspatha 10453 M ca. 2:3; (Fst. 2) 2 Lanzenspitze mit Kreuzmotiv. 1910/A 150 M ca. 1:2.

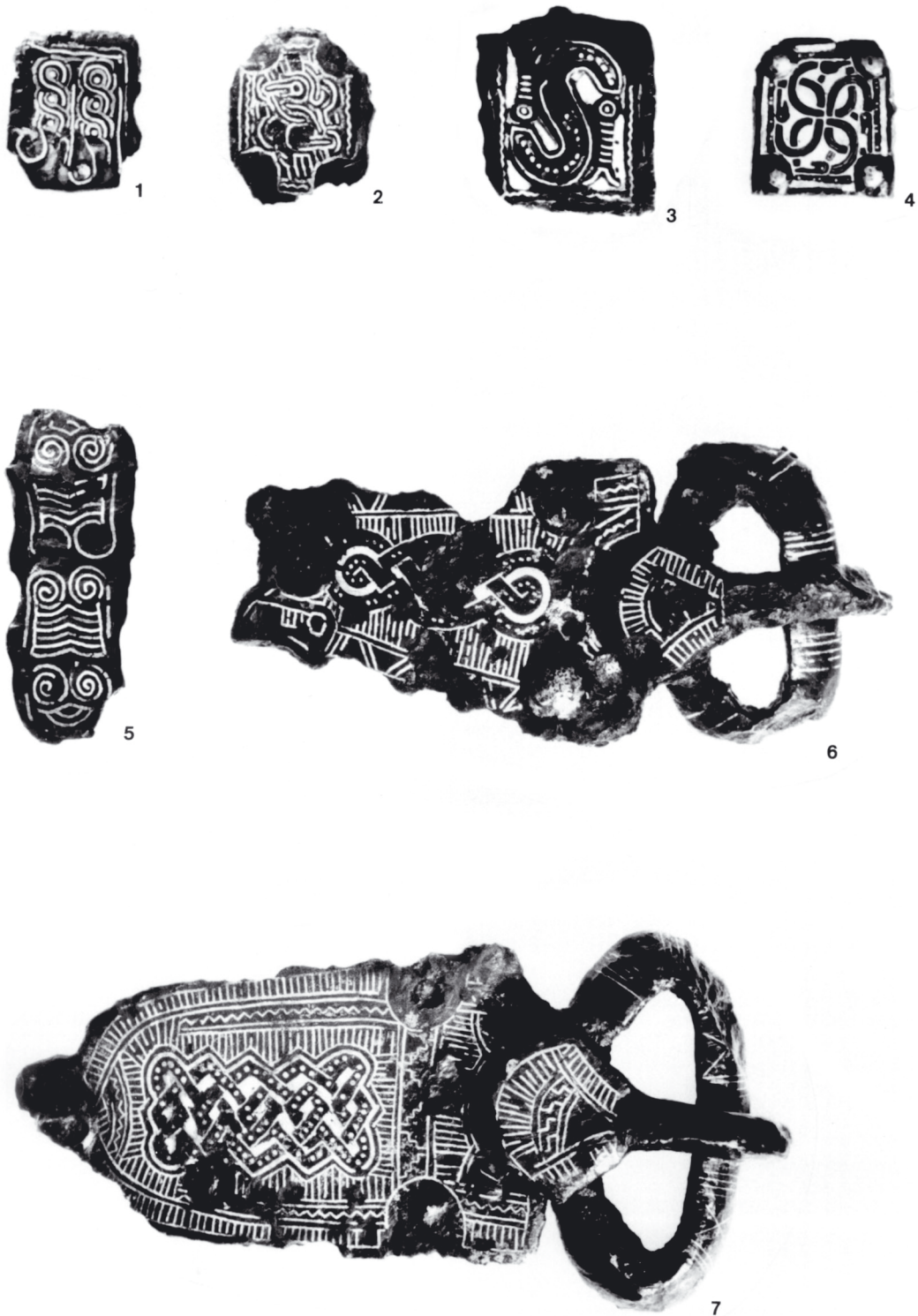

Sindelfingen (Fst. 1). Teile von Spathagehängen 1-4 F 84/18,47.48.50.53;
 Zaumzeugbeschläg 5 F 84/18,62; tauschierte Gürtelgarnituren 6.7 F 84/18,30.36. M ca. 1:1.



Sindelfingen (Fst. 1). Teile von vierteiligen Gürtelgarnituren, 1-6 F 84/18,7-13;
7.8 F 84/18,14.15; 9 F 84/18,27; 10-15 F 84/18,1-6. M. ca. 1:1.

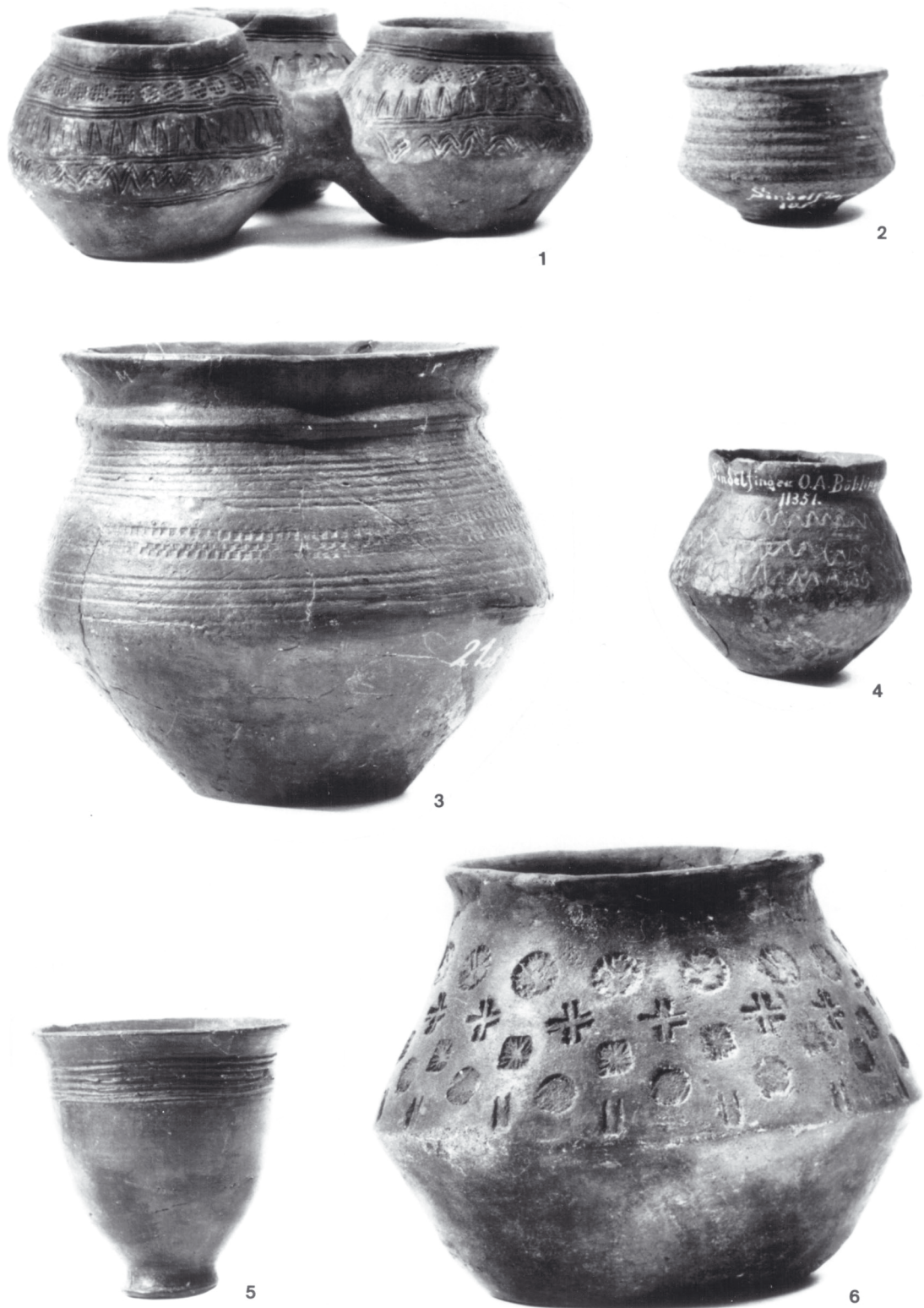

Sindelfingen (Fst. 1). Keramik. 1 F 84/32,9; 2 10843; 3 10350; 4 11351; 5 F 84/32,7; 6 F 84/32,8. M ca. 1:2.

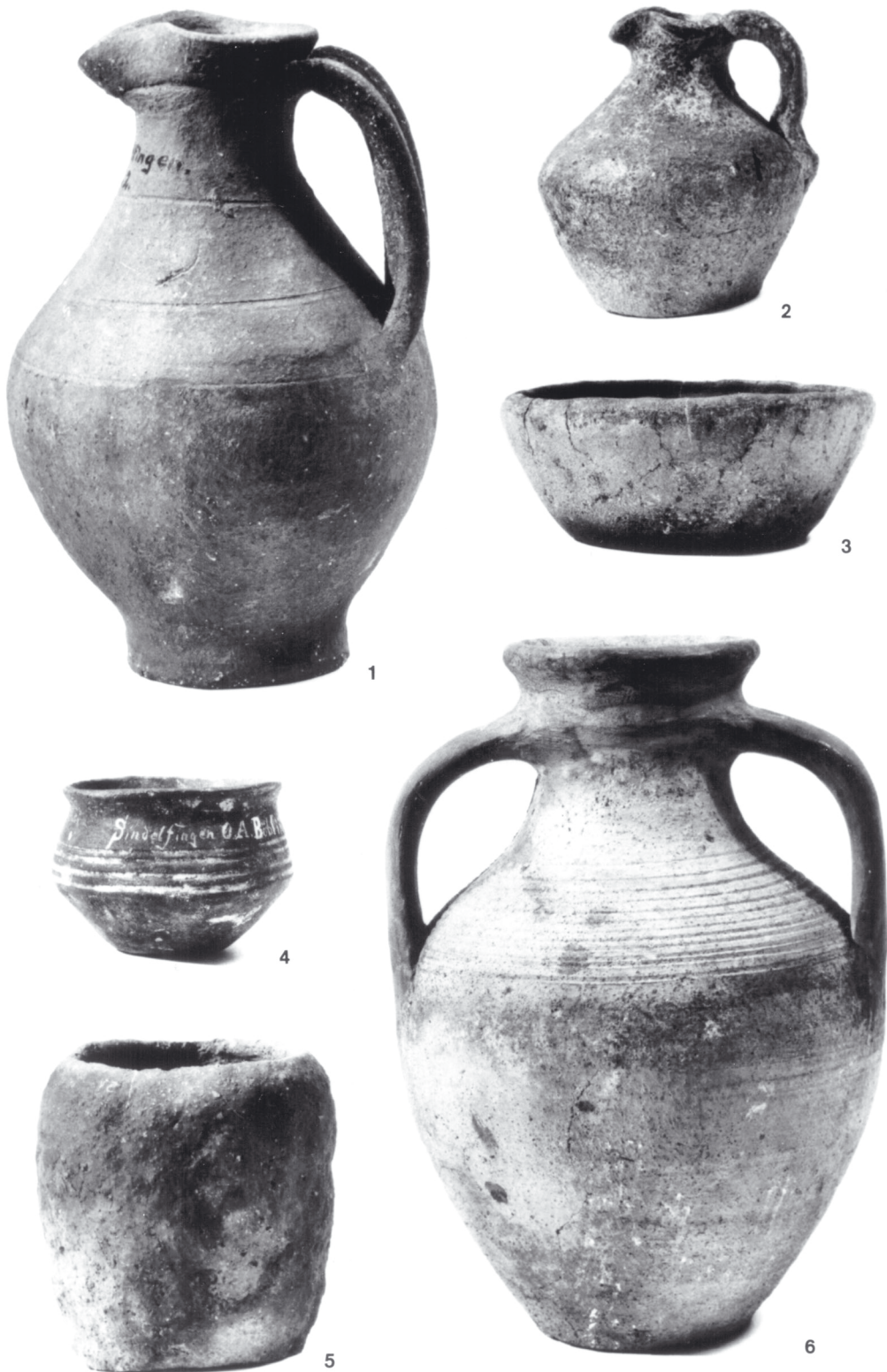

Sindelfingen (Fst. 1). Keramik. 1 F 84/32,12; 3 8538/8539; 4.5 10350;
6 8162-8192. (Fst. 2) 2 1956/Grab 1. M ca. 1:2.

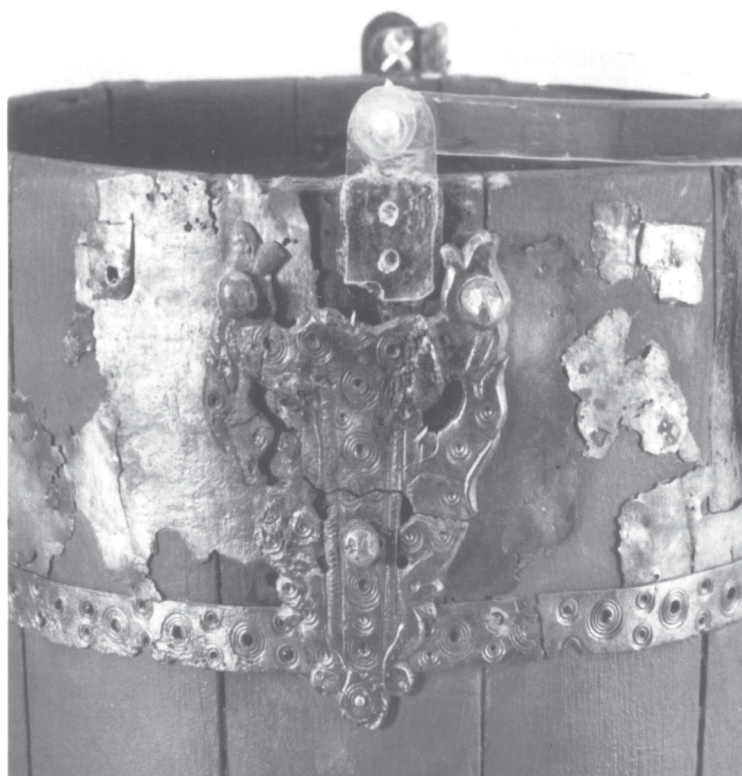
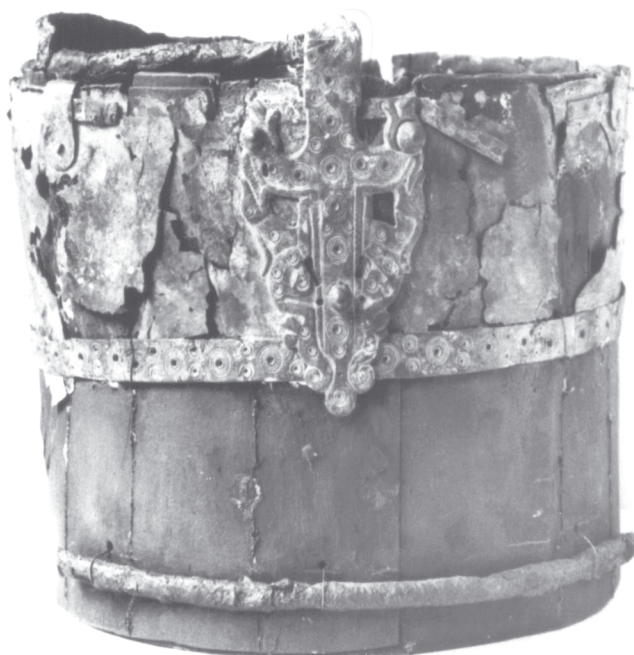

Dagersheim (Fst. 1), Grab 1897. Holzeimer. Oben: Eimer nach der ersten Restaurierung. Unten: Heutiger Zustand mit abgebrochener Henkelattasche.

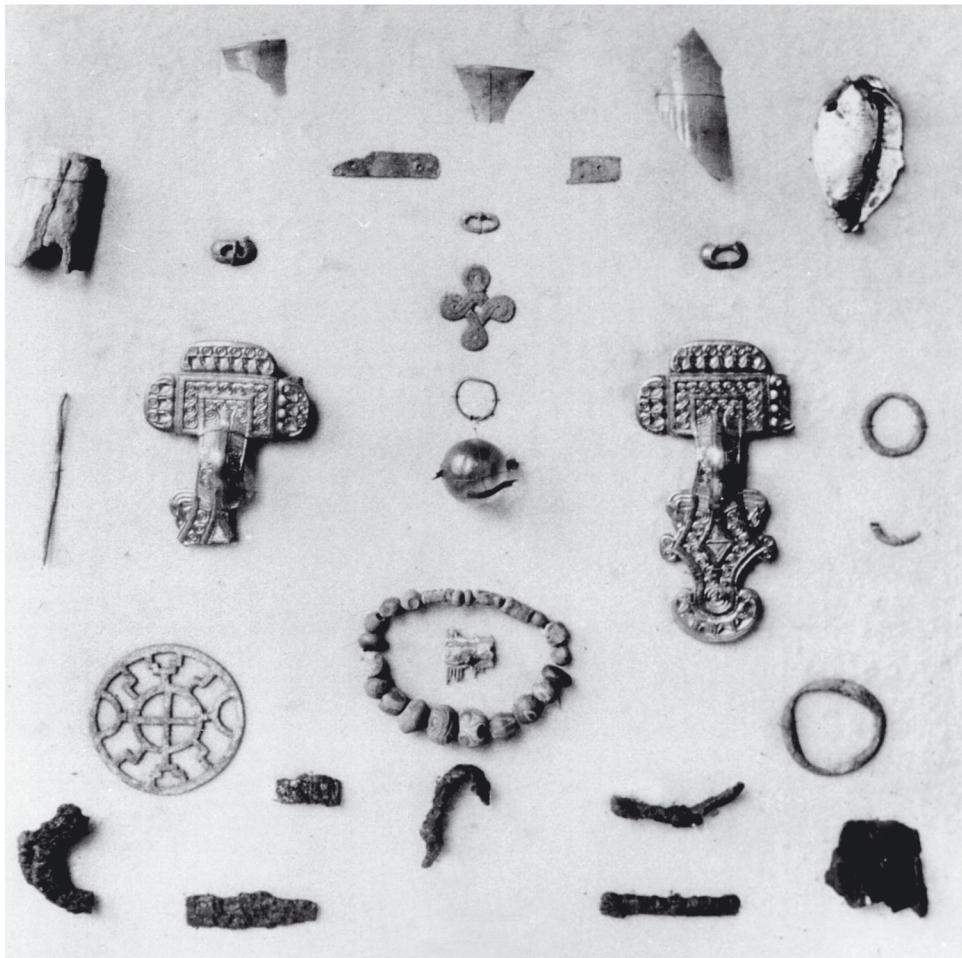

Dagersheim (Fst. 1), Grab 1897. Älteres Foto der Beigaben mit inzwischen verschollenen Objekten.



A



B

Glasperlen. A. Dagersheim (Fst. 1), Grab 1897. B 1 Dagersheim (Fst. 2), 1967/Grab 1; 2 Oberjesingen 1937/Grab.



1



2

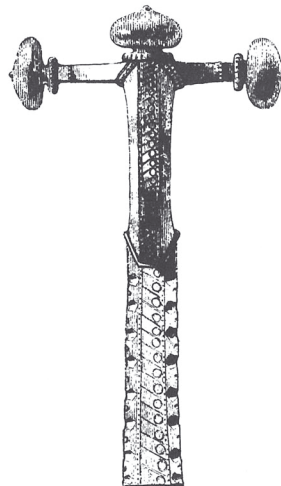

3

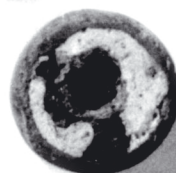
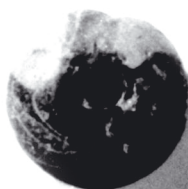

4

Ehningen (Fst. 1), Grab 13 2*; Grab 12 4. Kuppingen (Fst. 5) 3*. Darmsheim 1*.
1-3 verschollen.



Ehningen (Fst. 1). Grab 4.



A



B

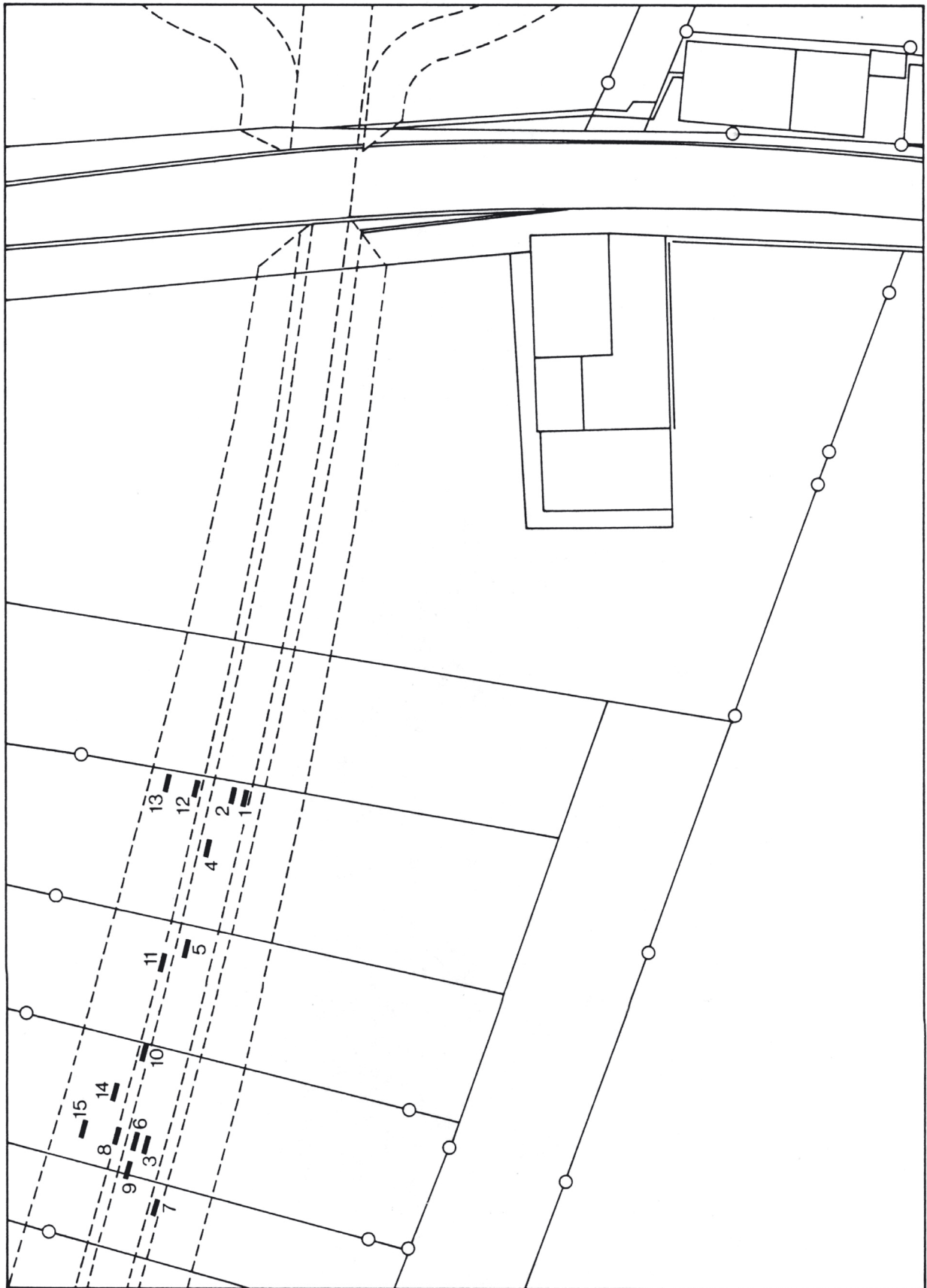

Ehingen (Fst. 1). Ausschnitt aus dem 1878 angefertigten Plan des Eisenbahnbauamtes mit den eingezeichneten Gräbern.

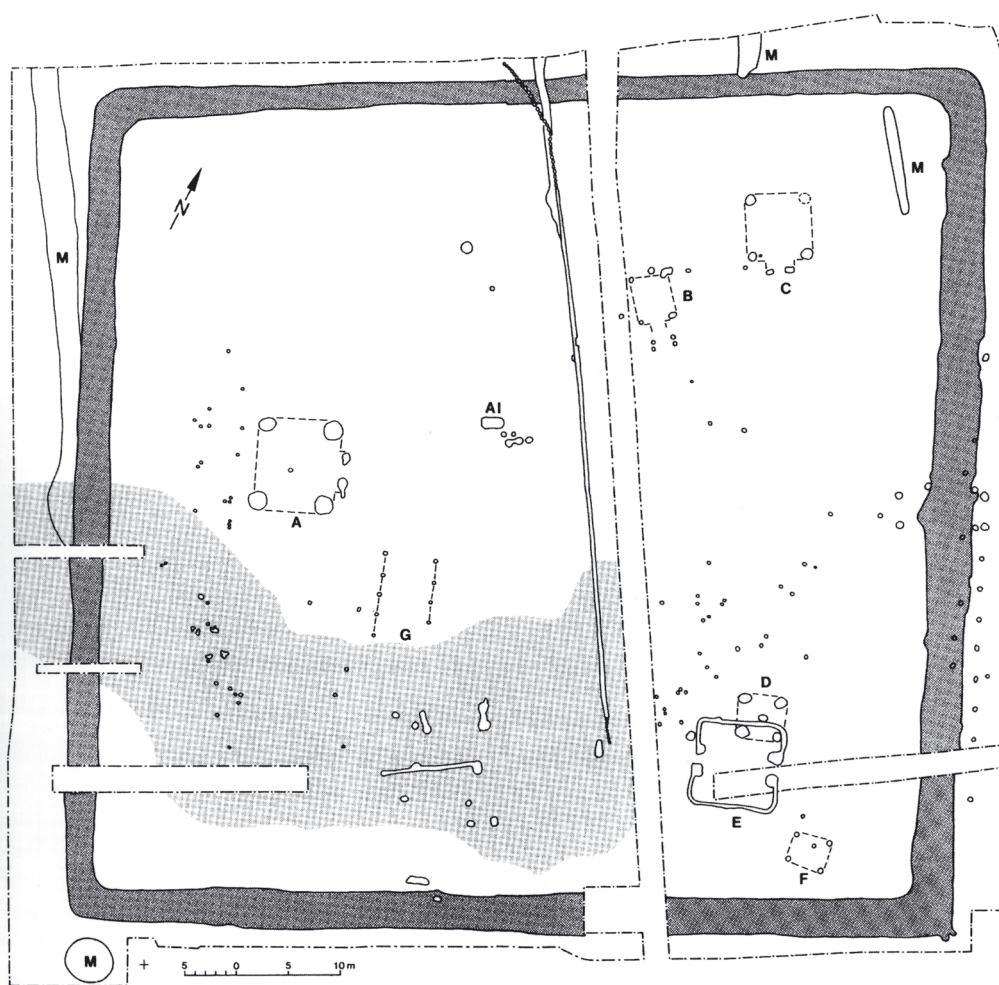

Ehningen (Fst. 2). Grundriß der keltischen Viereckschanze. AI Frauengrab; M spätmittelalterliche bis neuzeitliche Wegespuren und Grube.

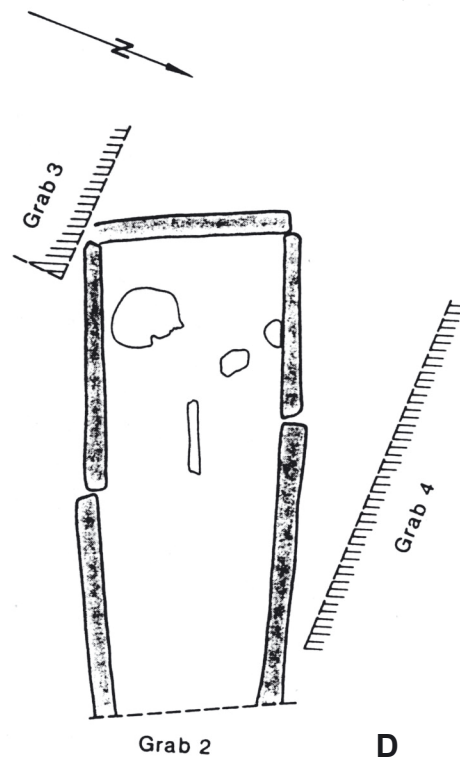
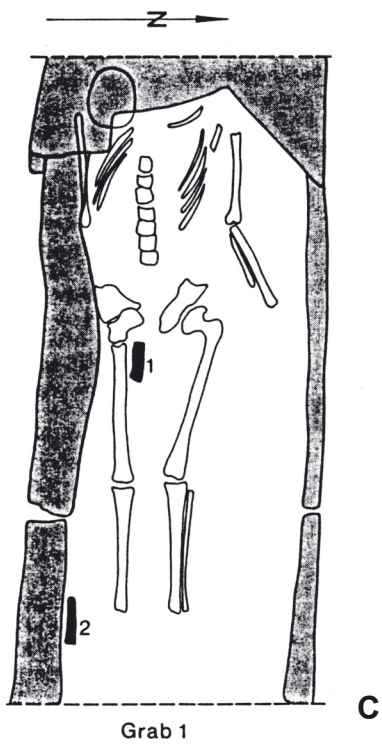
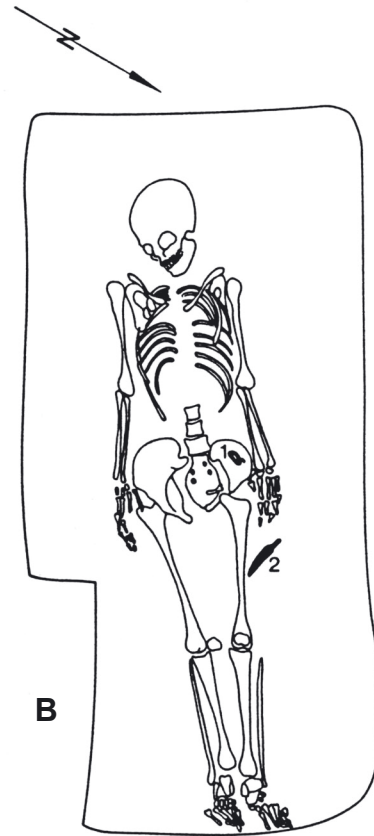
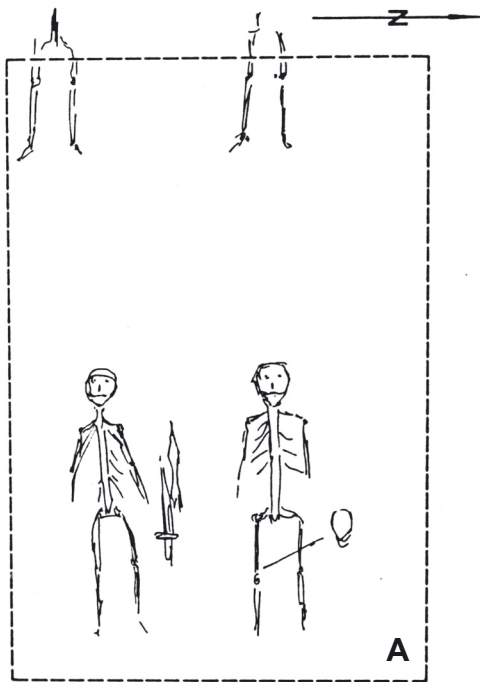

A Magstadt. Skizze der 1865 aufgedeckten Gräber. B Ehningen (Fst. 2), Frauengrab mit Messer (1) und Schnalle (2). C, D Darmsheim, 1957/Grab 1 und 2. B-D M 1:20.



Kuppigen (Fst. 4). Notbergung 1972, Frauengrab v. NO.



A



B

Darmsheim. Notbergung 1957. A 1957/Grab 2 Steinplattengrab von O; B Trockenmauergrab von NW (nicht untersucht).



Lage der Fundstellen von Sindelfingen und Böblingen. Bestattungsplätze 1-3, 15;
Siedlungen u. Wüstungen 4-14, 16. Ausschnitt aus der TK 1:25000 7219, 7220, 7319, 7320.

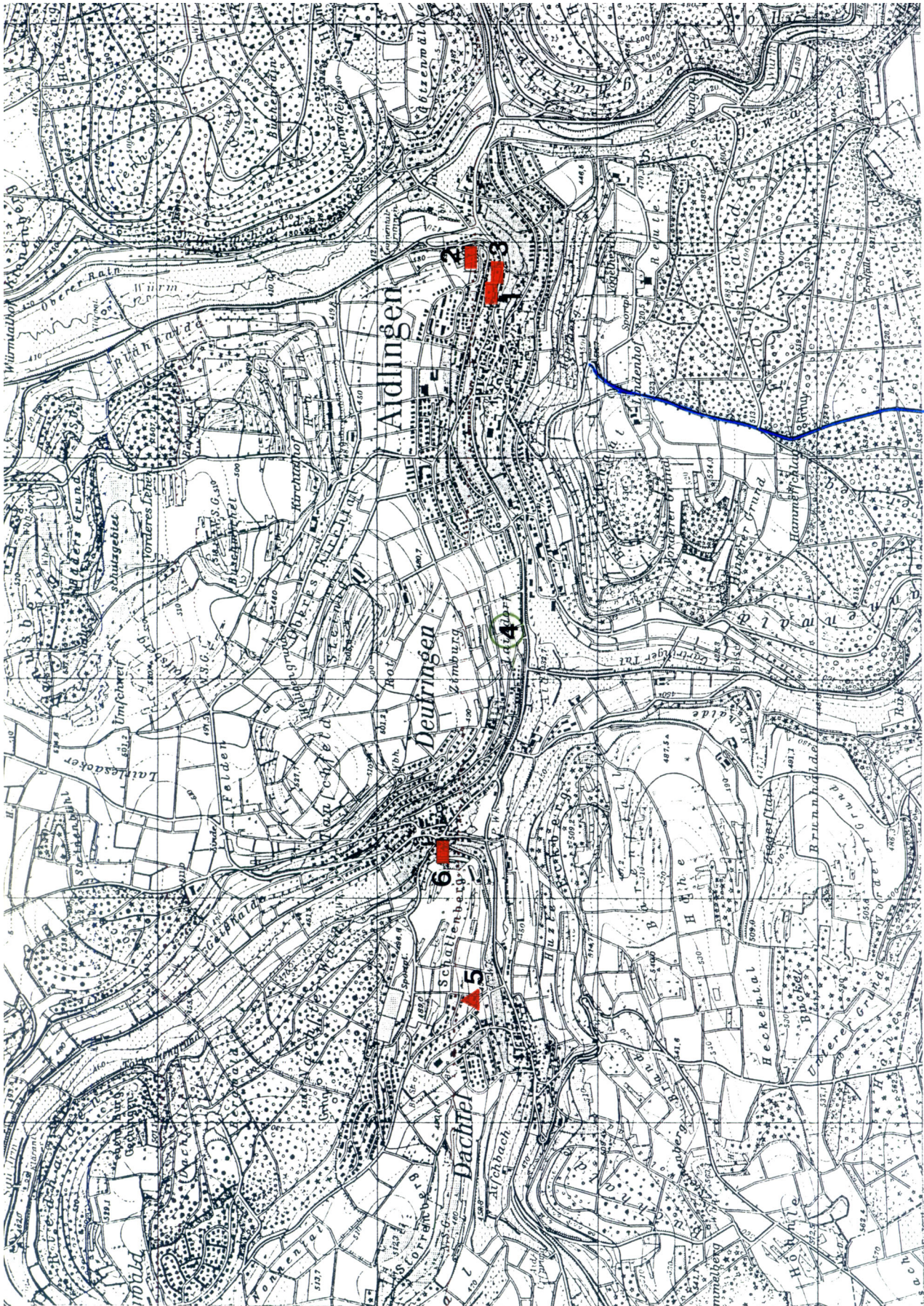

Lage der Fundstellen in Ailingen, Dachtel und Deufringen, vermuteter Straßenverlauf.
Ausschnitt aus der TK 1:25000 7319.



Lage der Fundstellen in Deckenpfronn, vermuteter Verlauf der Römerstraße Rottenburg-Pforzheim. Ausschnitt aus der TK 1:25000.

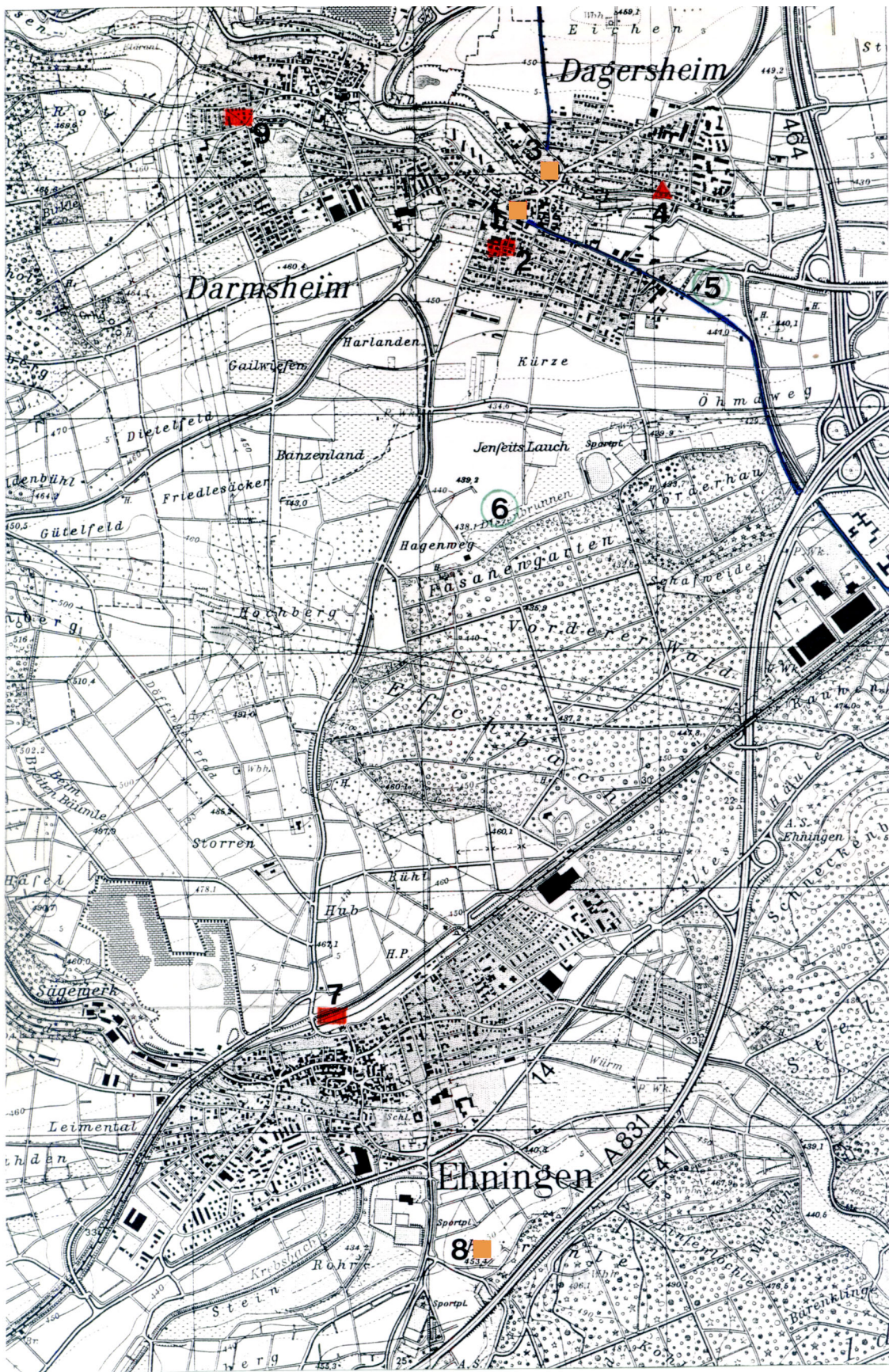

Lage der Fundstellen in Ehningen, Darnsheim und Dagersheim, vermuteter Verlauf der Rheinstraße. Ausschnitt aus der TK 1:25000 7319.

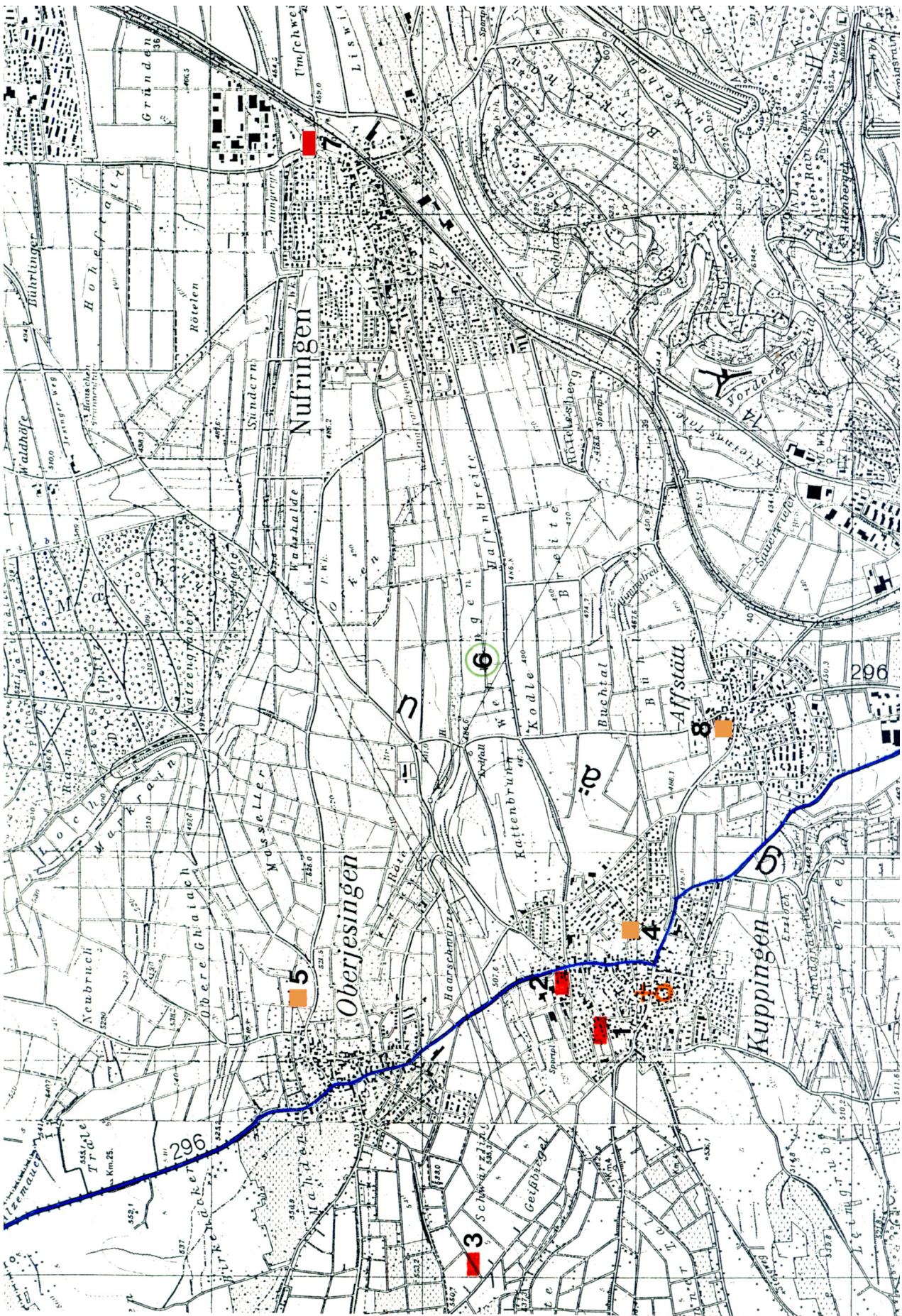

Lage der Fundstellen in Kuppingen, Nufringen und Oberjesingen, vermuteter Verlauf der Römerstraße Rottenburg-Pforzheim Ausschnitt aus den TK 1:25000 7318, 7319.

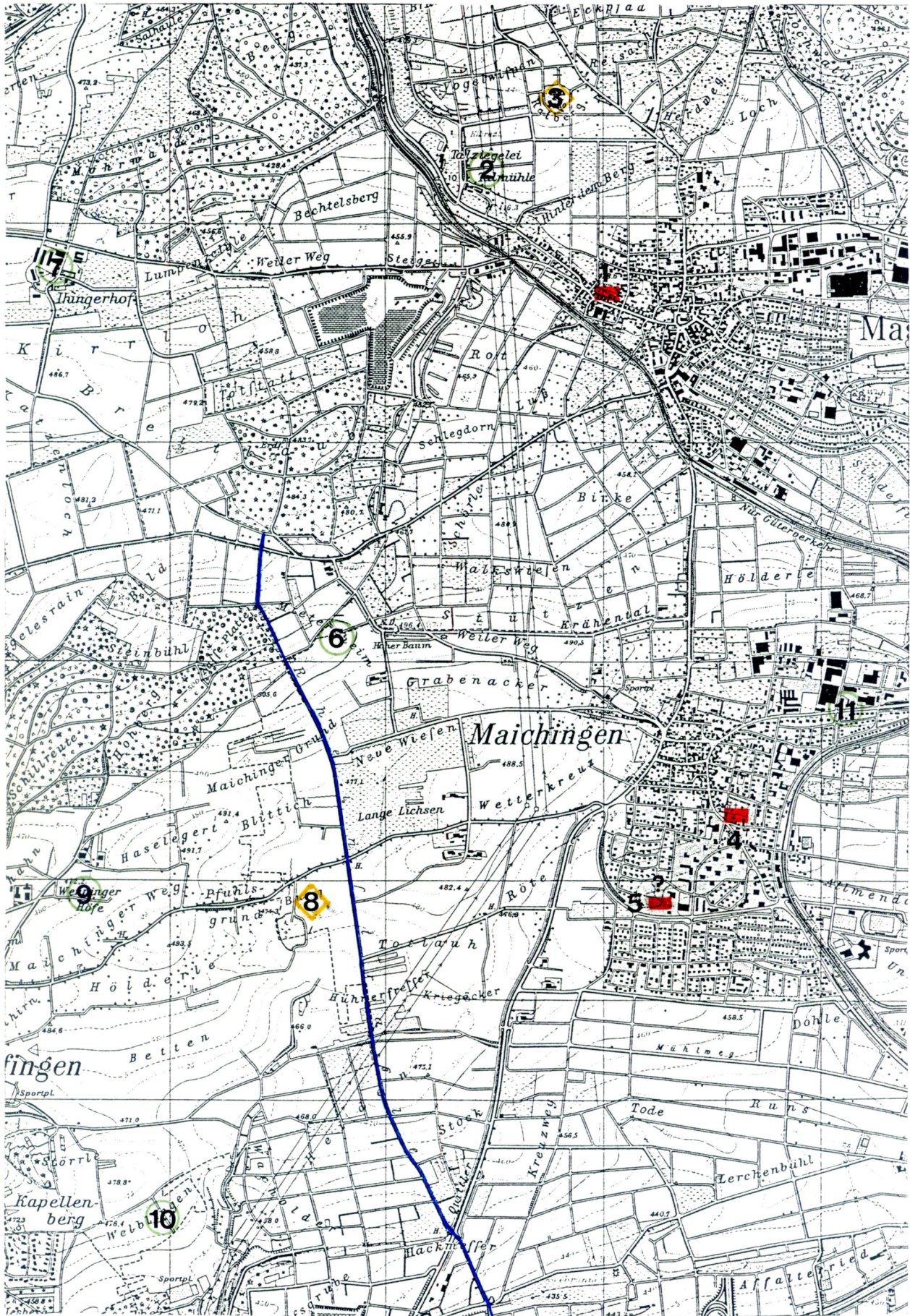

Lage der Fundstellen in Magstadt und Maichingen, vermuteter Verlauf der Rheinstraße.
Ausschnitt aus der TK 1:25000 7219.

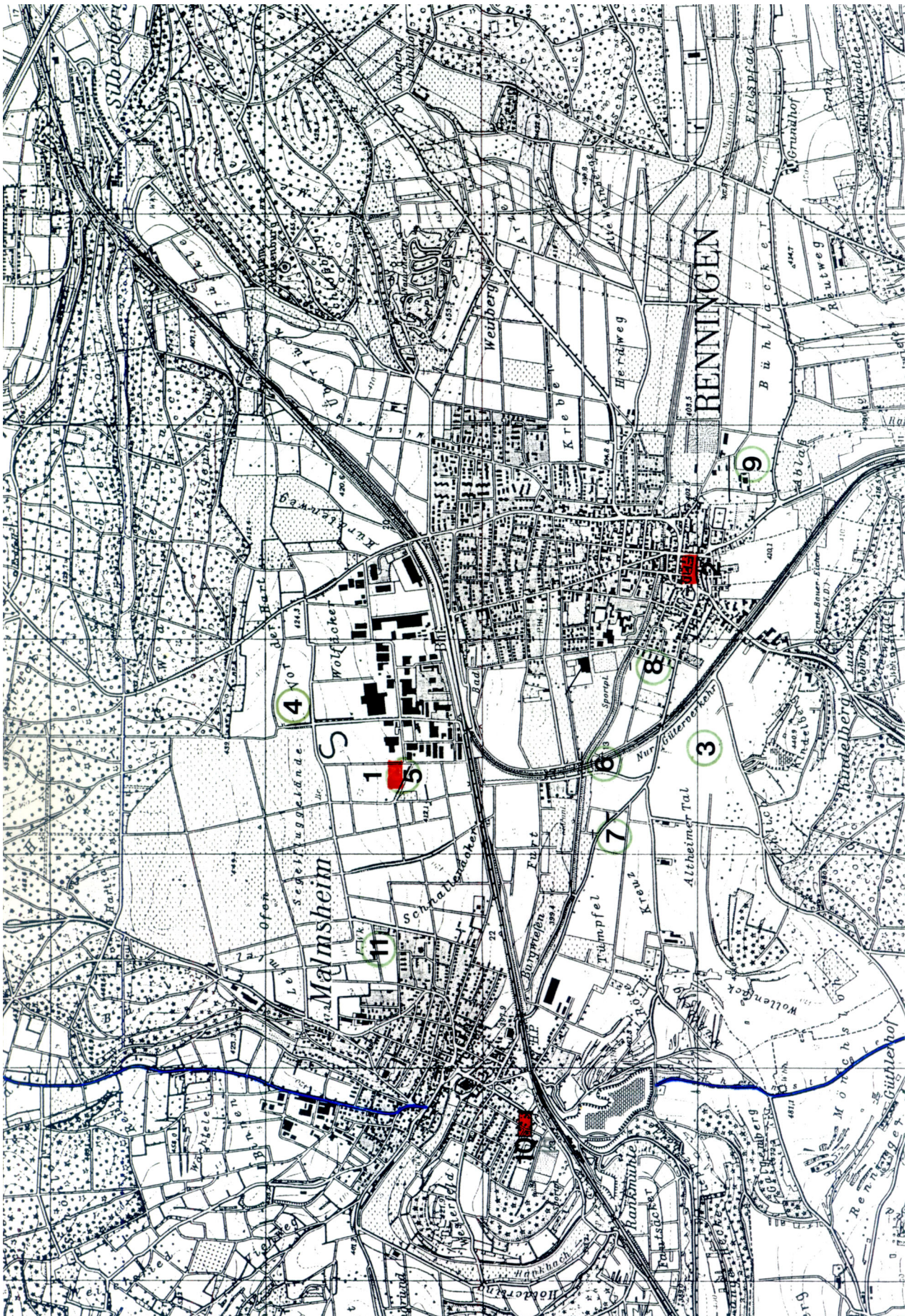

Lage der Fundstellen in Renningen und Malsheim, vermuteter Verlauf der Rheinstraße.
Ausschnitt aus der TK 1:25000 7219.

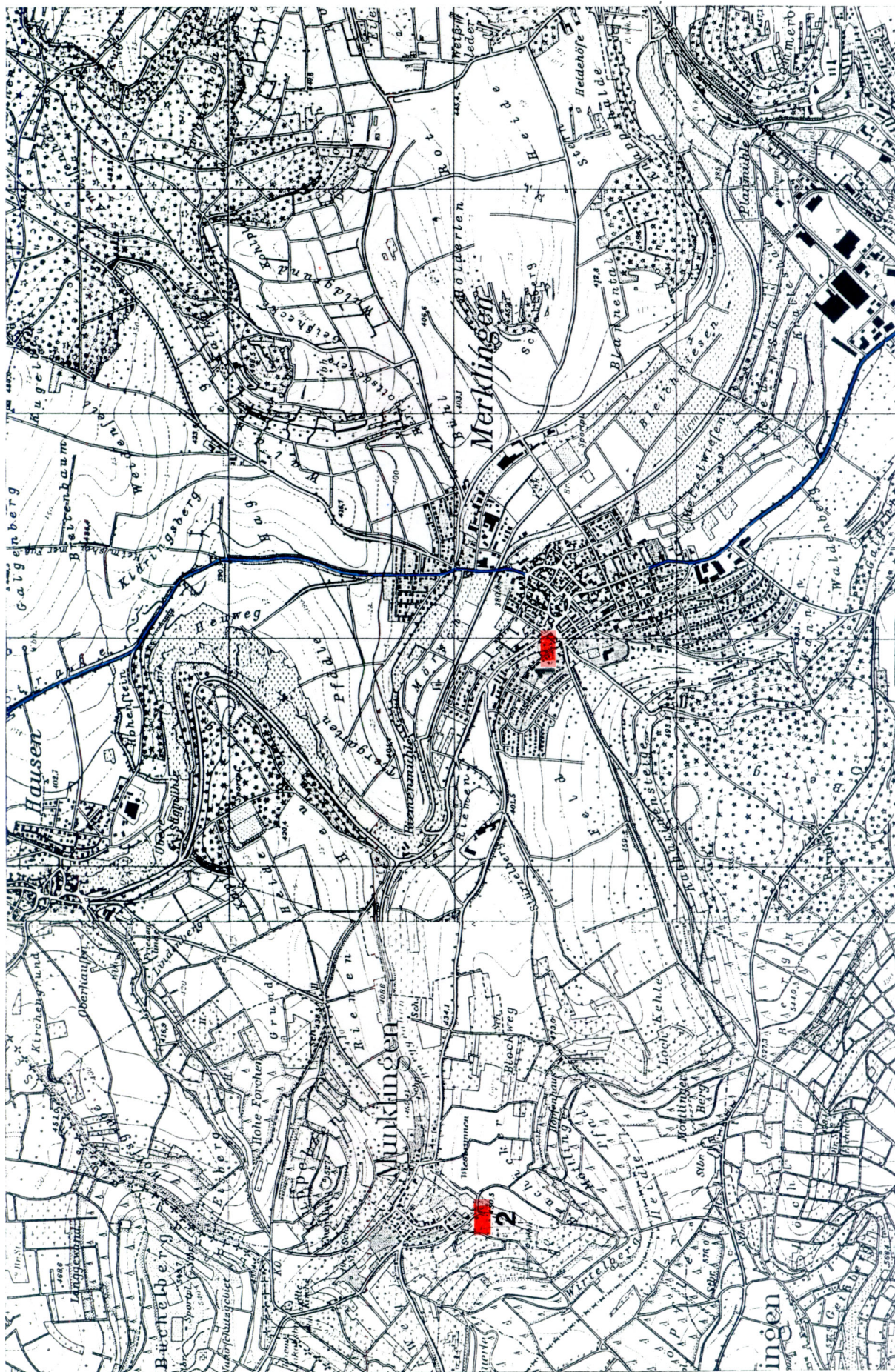

Lage der Fundstellen in Merklingen und Münklingen, vermuteter Straßenverlauf.
Ausschnitt aus den TK 1:25000 7218, 7219.

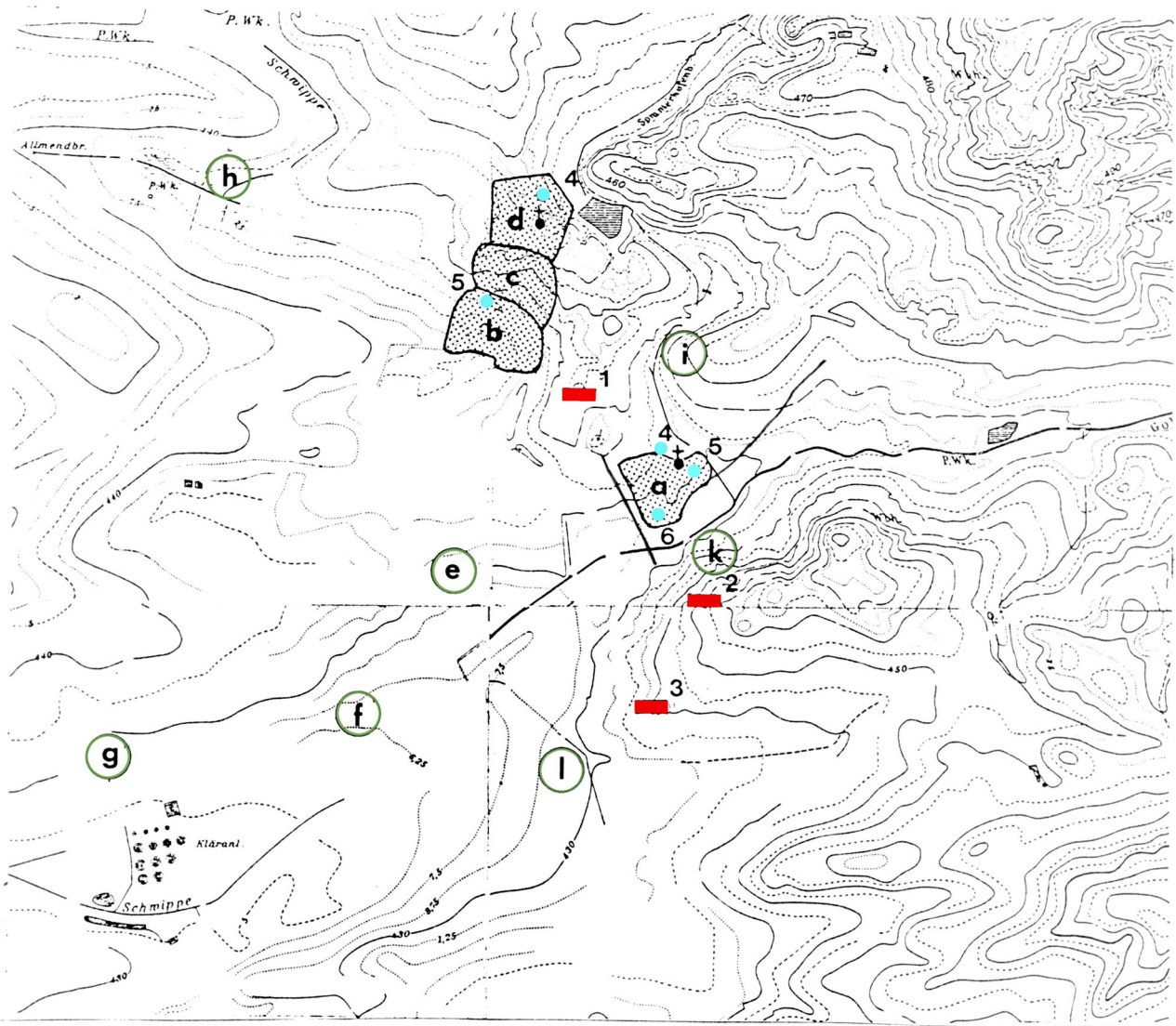

Sindelfingen. Lage der Fundstellen. Gräberfelder 1-3; archäologisch nachgewiesene Siedlungsbereiche a-d mit wichtigen Fundstellen 4-5 (Sindelfingen), 4-6 (Altingen), vermutete Wüstungen e-l und erschlossener Verlauf der römischer Straßen. Ausschnitt aus den Orohydrographische Karten 1:25000 7219, 7220, 7319, 7320.

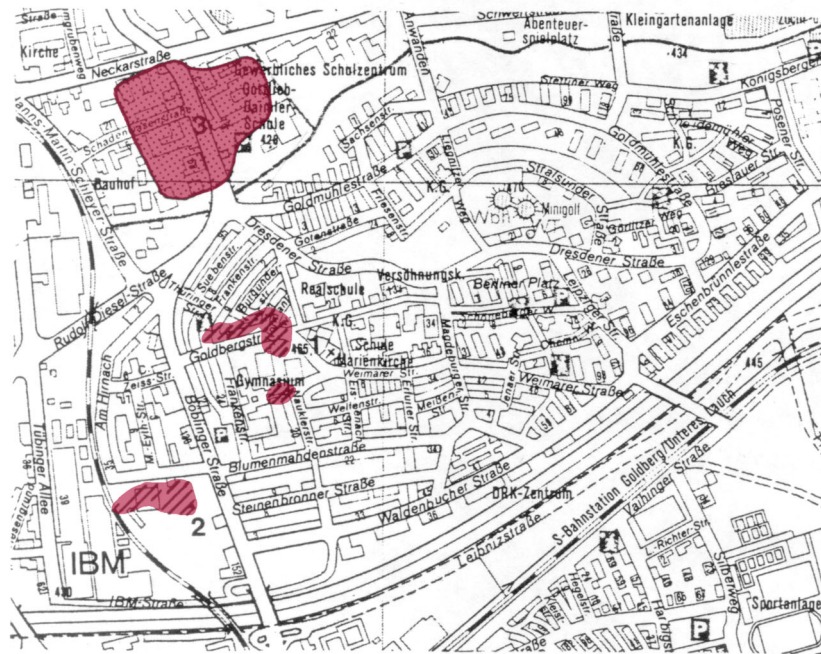

Sindelfingen. 1 Gräberfeld „Goldberg“ (Fst. 2); 2 Gräberfeld „Hirnach“ (Fst. 3); 3 Wüstung „Altingen“. Ausschnitt aus dem Stadtplan Sindelfingen/Böblingen 1:15000.

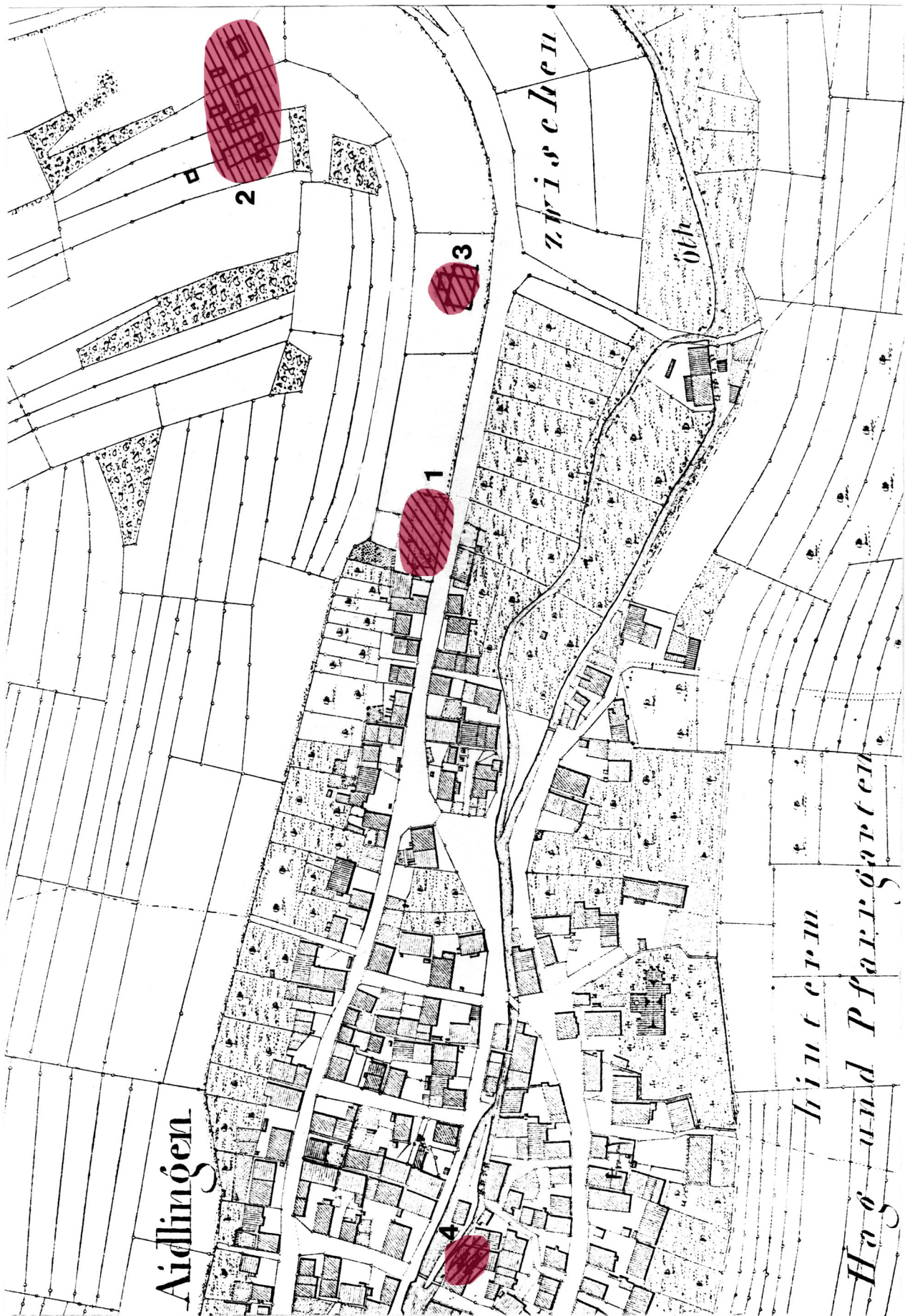

Lage der Fundstellen in Aidlingen. Flurkarte NW 1610.

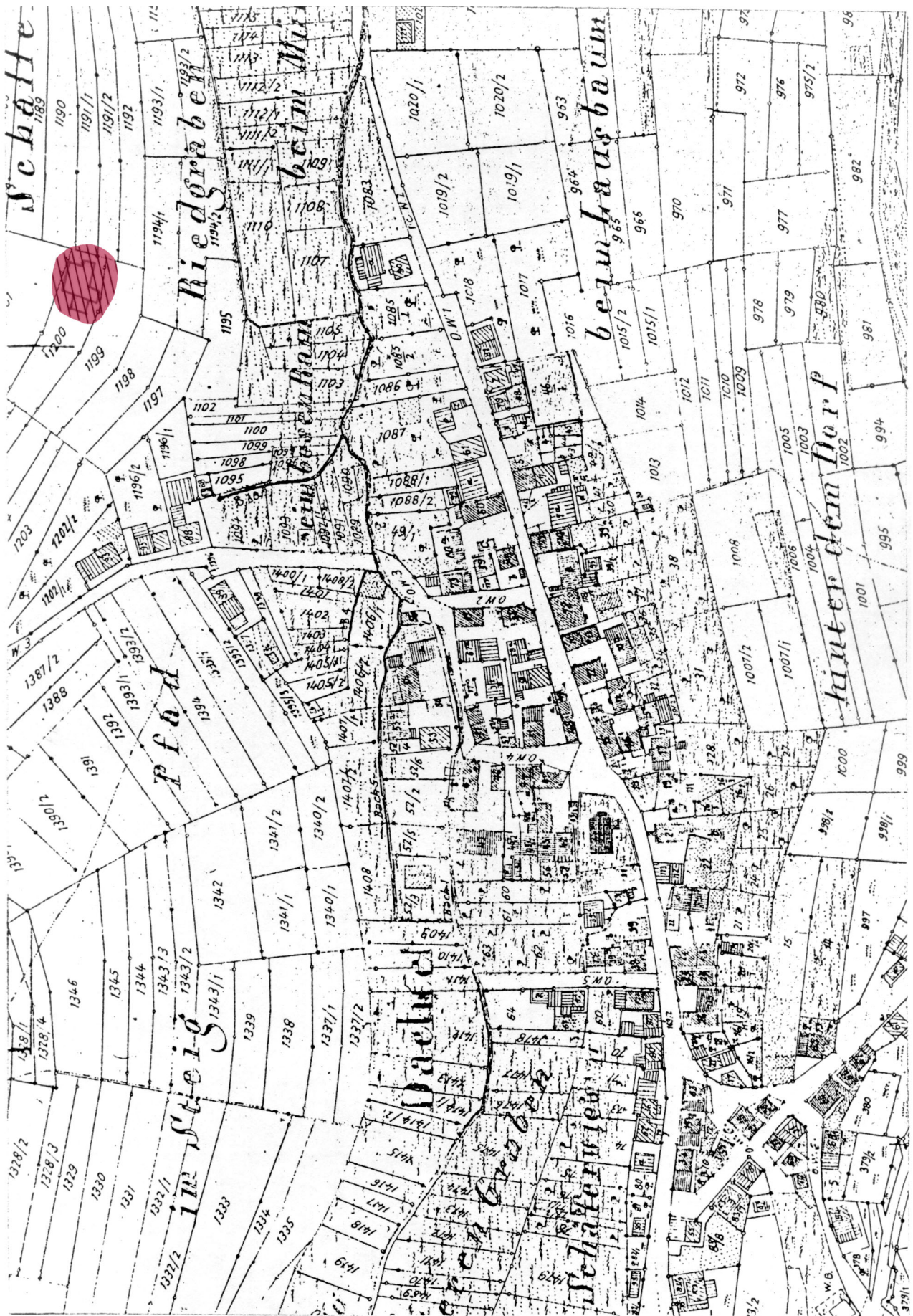

Lage der Fundstelle in Dachtel. Flurkarte NW 1613.

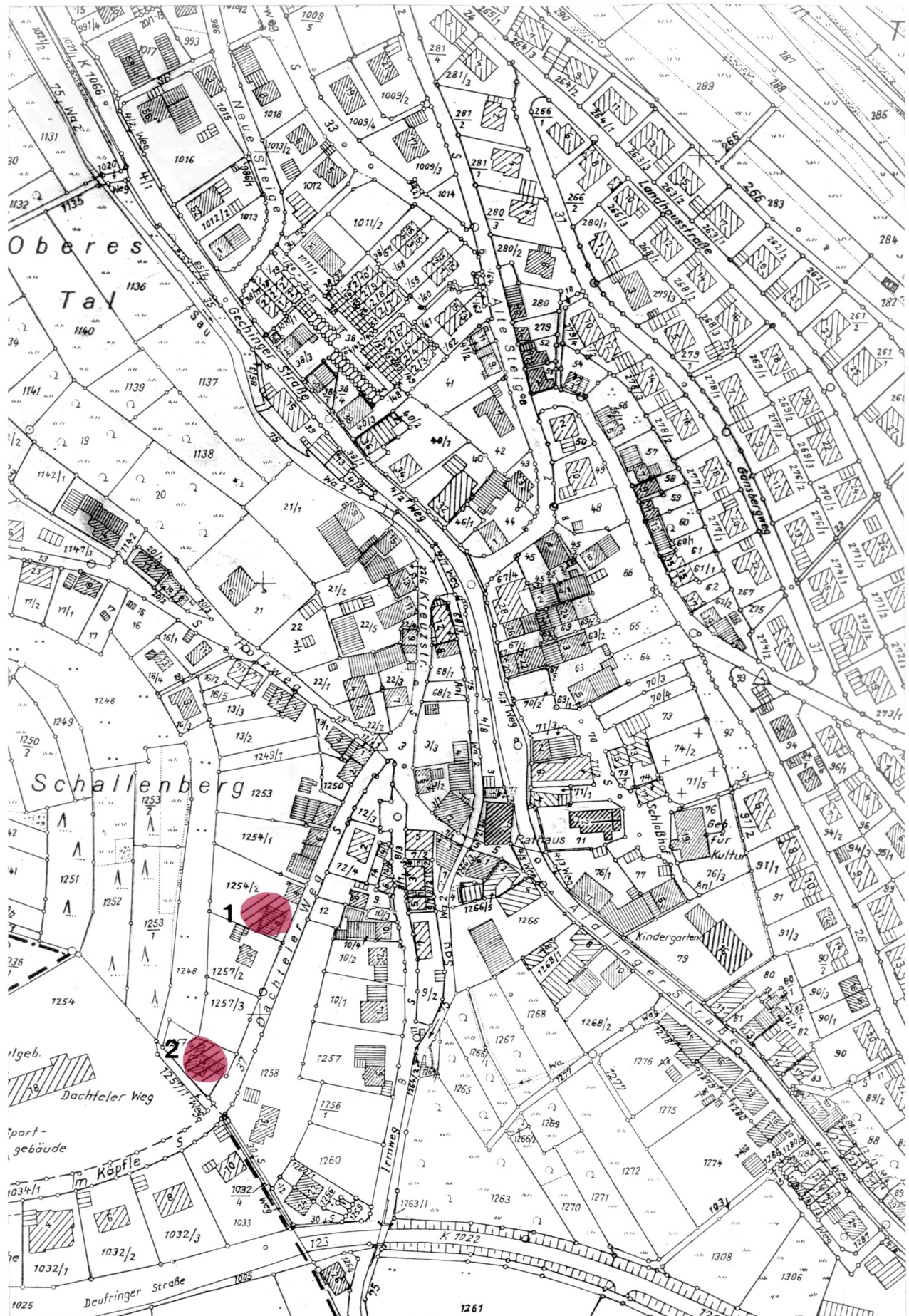

Lage der Fundstelle in Deufringen. Flurkarte NW 1612.



Lage der Fundstellen in Böblingen. Flurkarte NW. 1603.

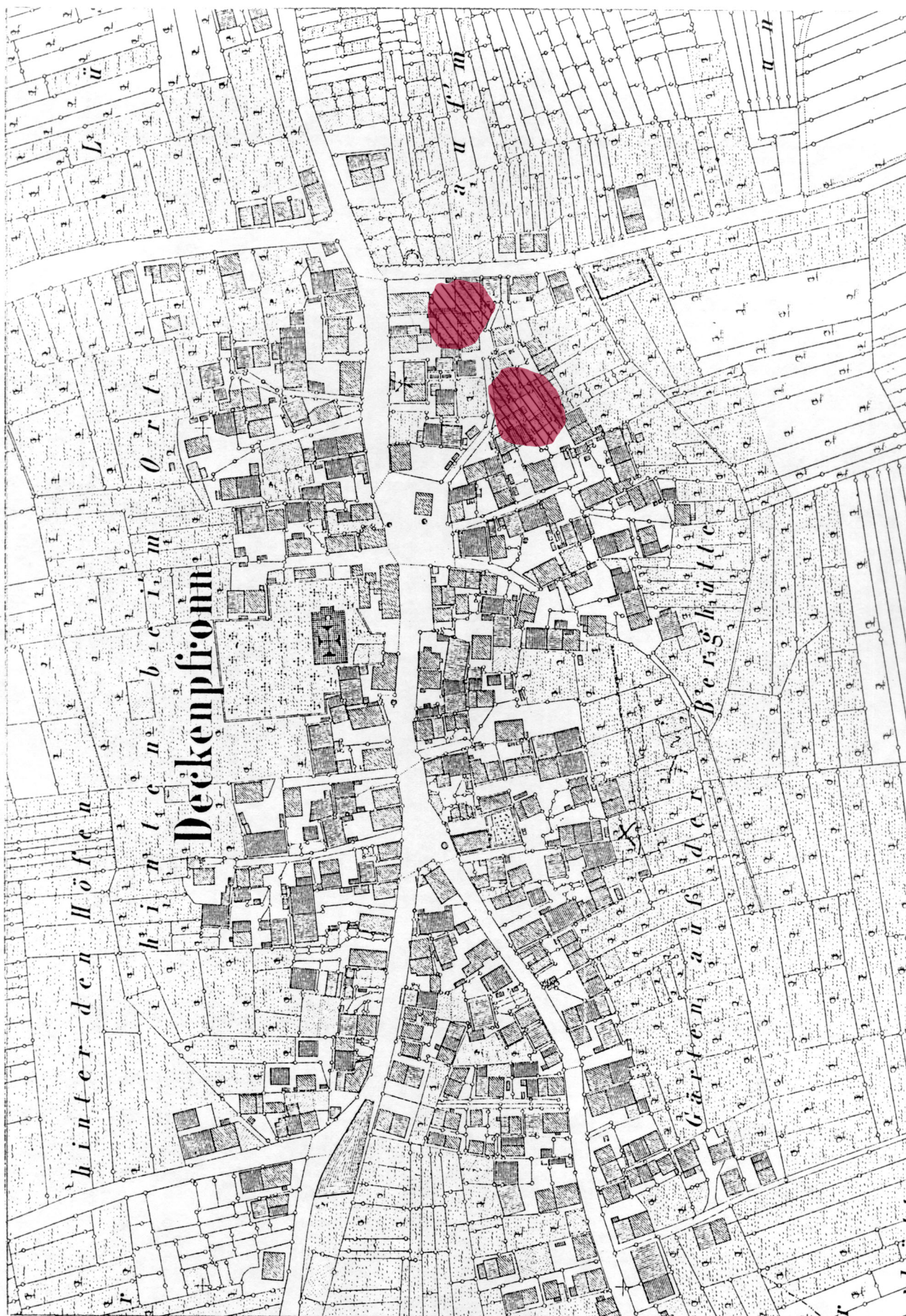

Lage der Fundstelle in Deckenpfronn. Flurkarte NW 1315.

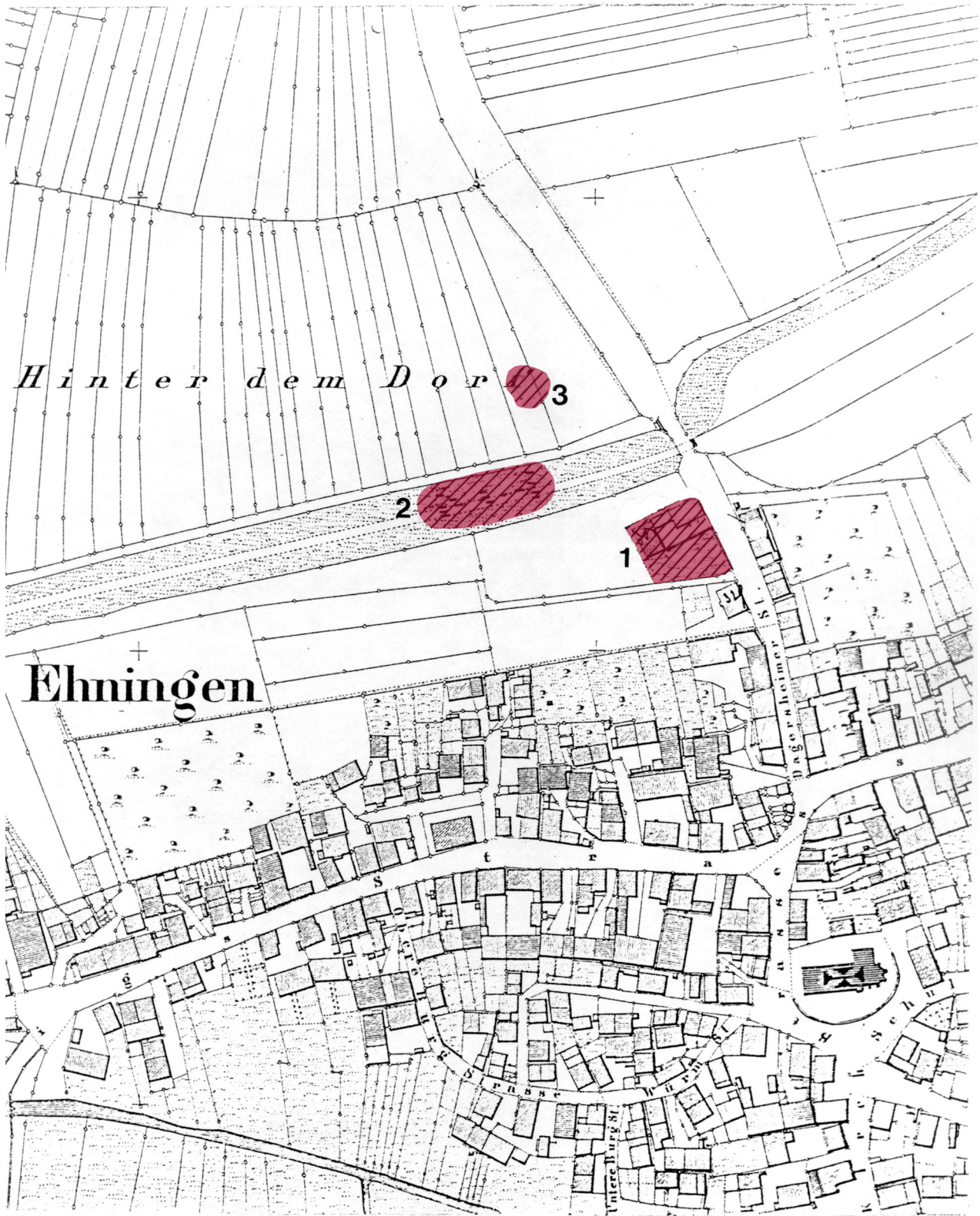

Lage der Fundstellen in Ehningen. Flurkarte NW 1408.

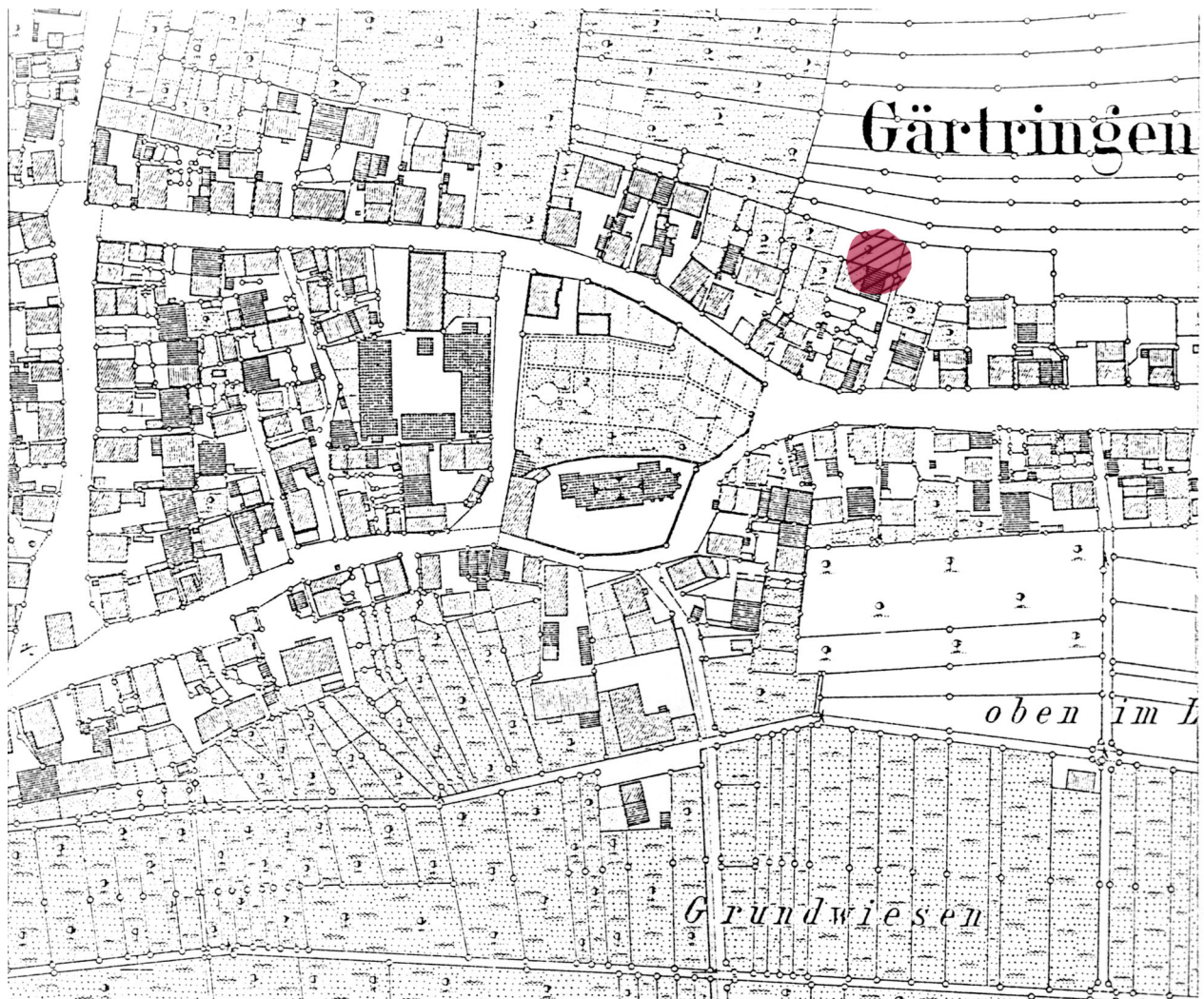

Lage der Fundstellen in Gärtringen. Flurkarte NW 1210.

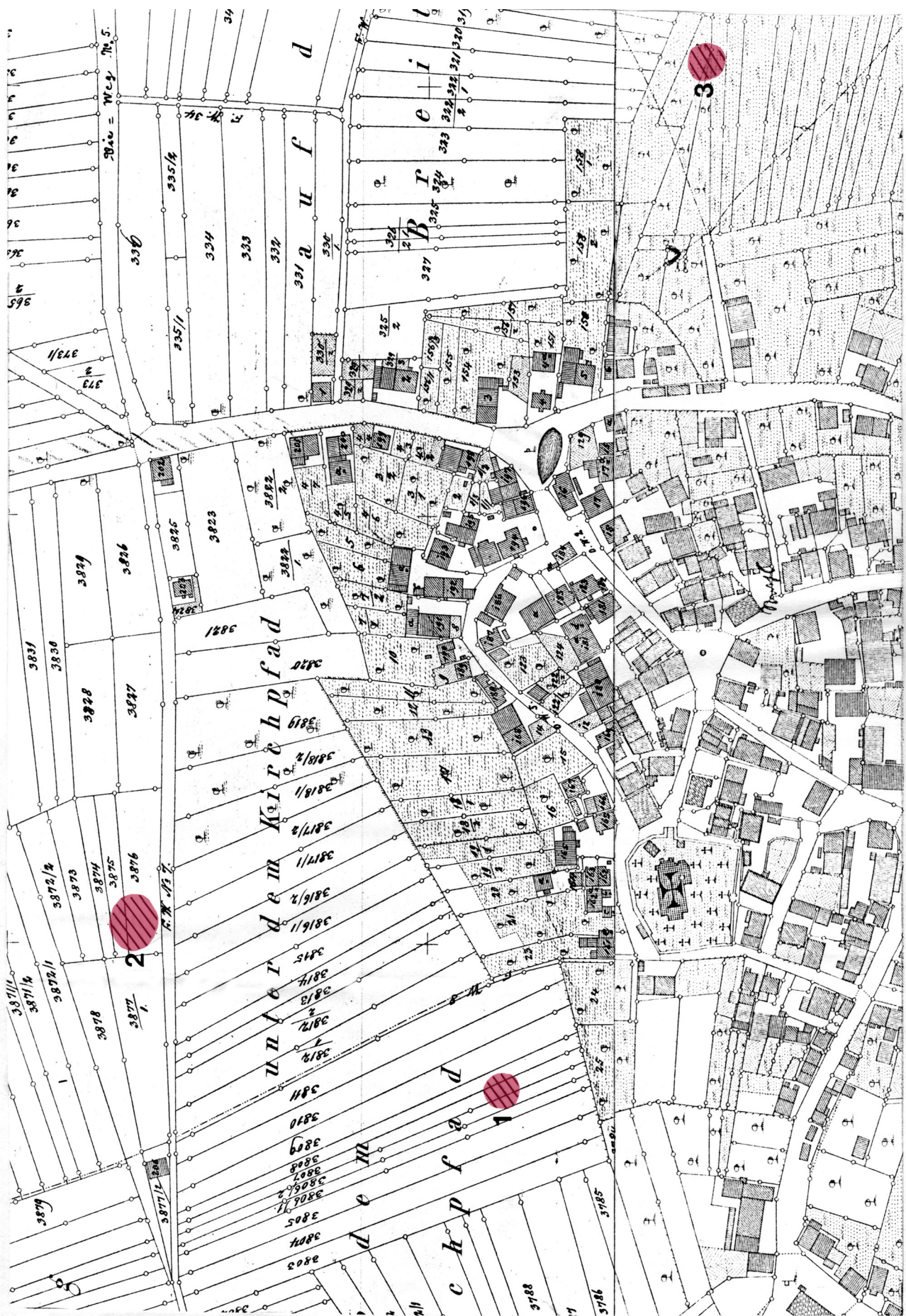

Lage der Fundstellen in Kuppingen. Flurkarte NW 0914/1014.

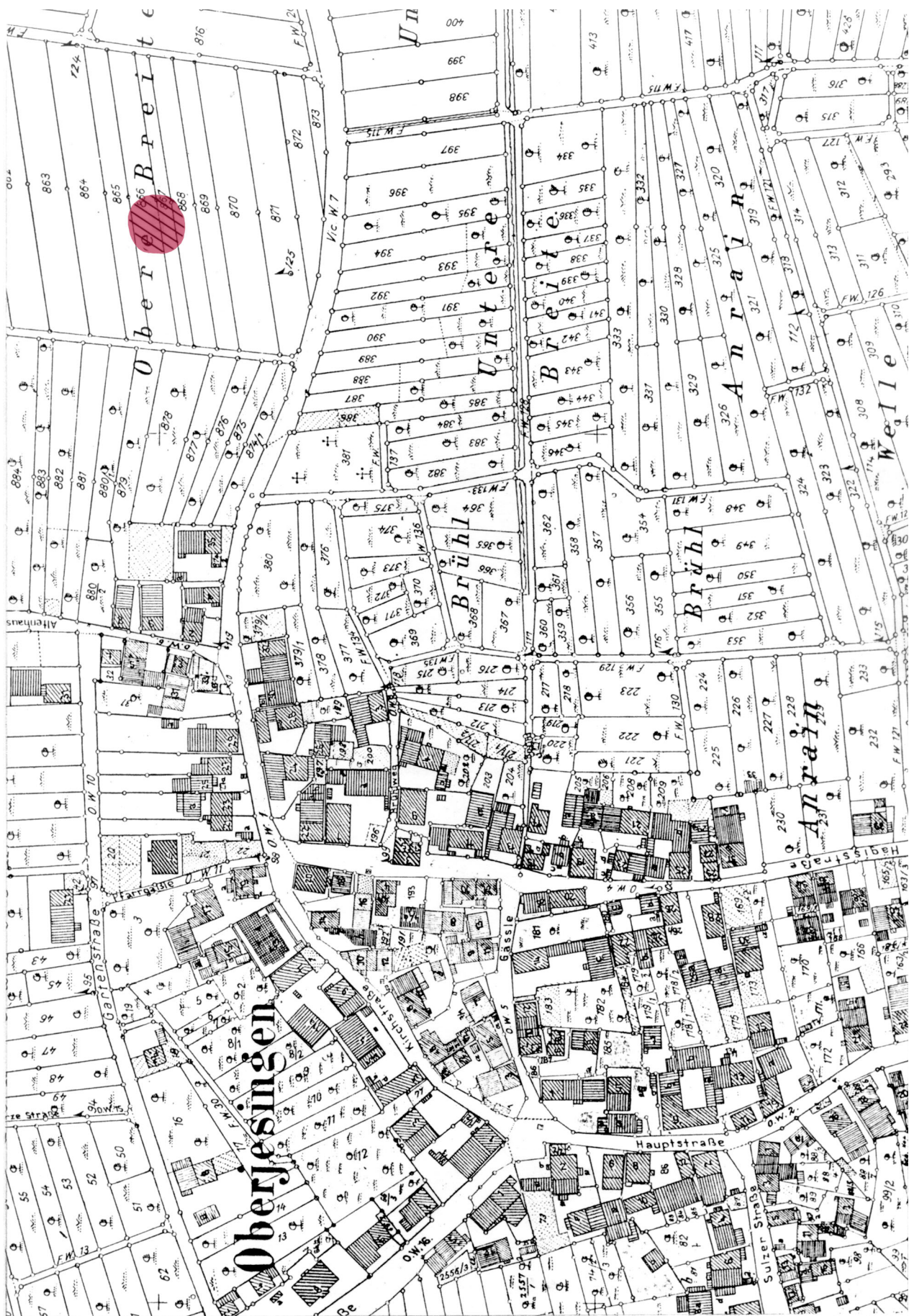

Lage der Fundstelle in Oberjesingen. Flurkarte NW 1114.

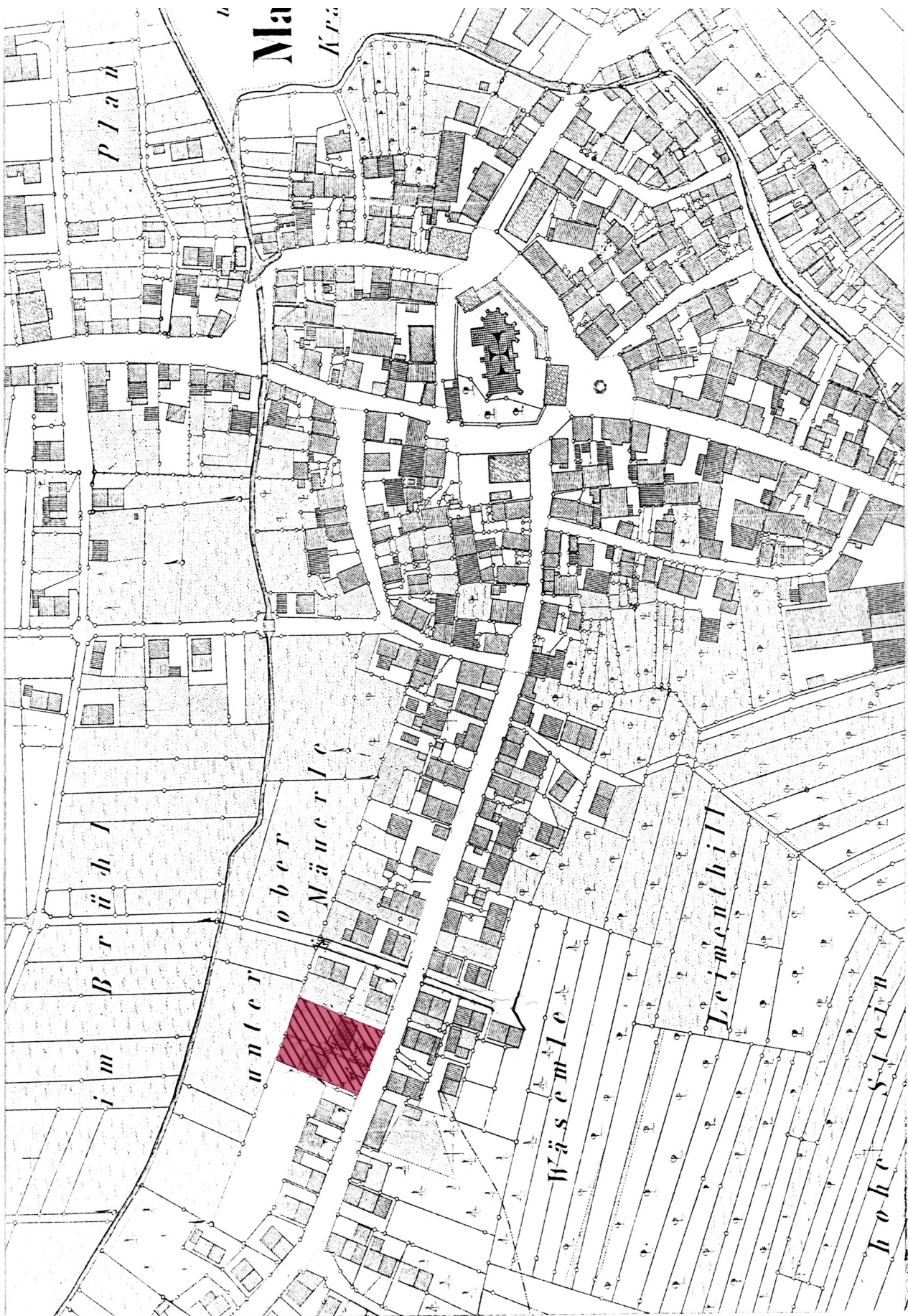

Lage der Fundstellen in Magstadt. Flurkarte NW 2205.



Lage der Fundstelle in Nufringen. Flurkarte NW 1110/1111.



Lage der Fundstelle in Malsheim. Flurkarte NW 2510.



Lage der Fundstellen in Darmsheim. Flurkarte NW 1708/1808.



Lage der Fundstelle in Maichingen. Flurkarte NW 2006.

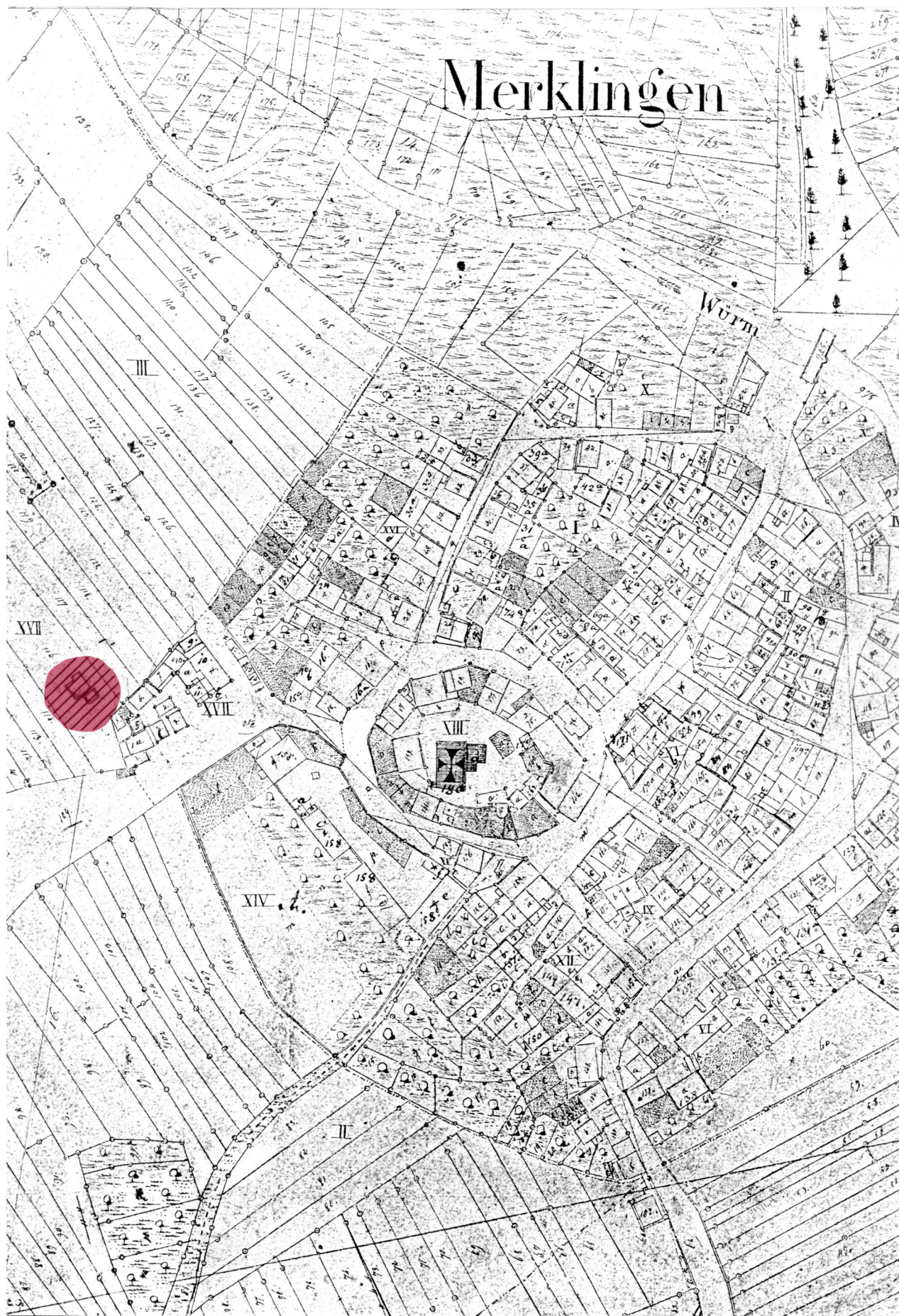

Lage der Fundstelle in Merklingen. Flurkarte NW 2513/2514.



Lage der Fundstelle in Münklingen. Flurkarte NW 2516.

A

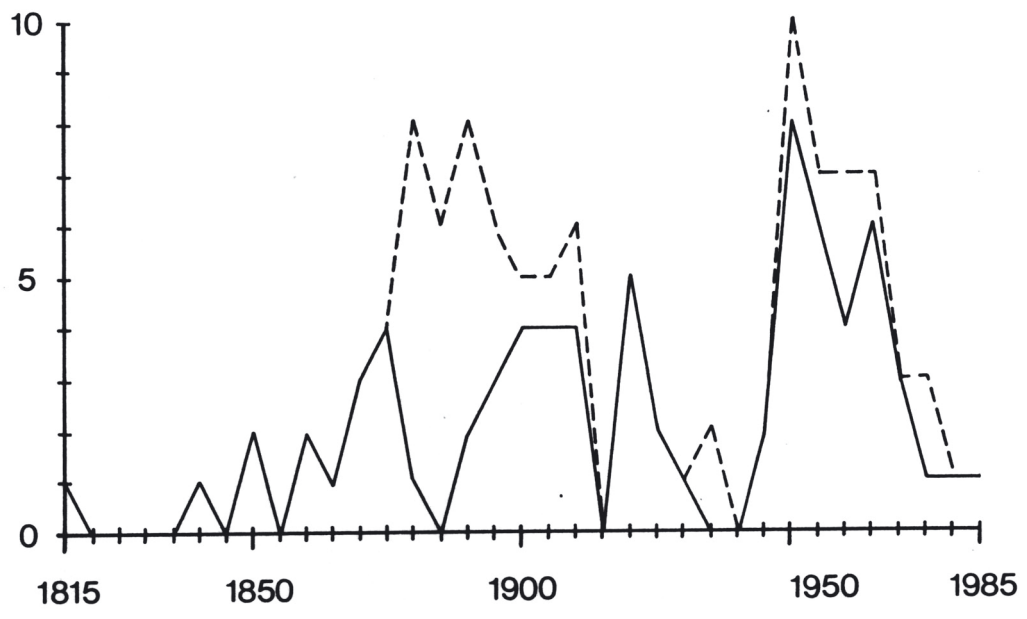

B

	Spatha	Sax	Lanze	Pfeil	Schildbuckel	Dreit. Gürtelgarnitur	Messer	Feuerstahl	Pfriem	Tongefäß
1956/Grab 1				●			●			●
1967/Grab 1	●	●			●	●		●	●	
1975/Grab 1	●									
1975/Grab 4	●									

A Fundmeldungen im Arbeitsgebiet zwischen 1815-1895.
 — ohne Sindelfingen ---- mit Sindelfingen.

B Sindelfingen, Gräberfeld „Goldberg“ (Fst. 2). Waffenführende Gräber.

	Spatha	Spathascheiden beschlag	Spathagehänge	Sax	Saxscheiden beschlag	Lanze	Axt	Pfeil	Schildbuckel	Schildfessel	Dreit. Gürtelgarnitur	Vielt. Gürtelgarnitur	Bronz. Gürtelgarnitur	Sporn/ Sporngarnitur	Trense	Pferdezaumzeug
8162-8192				○ ● 2	●						○ 3					
8489		●	●?	● 2	●	●			○		○ 4	●?				
8538/8539				● 2		● 2 ○			●							
8566				○	●	●		● 3								
8648	●			●				● 2								
8670	●			●	○				●	●	○					
8754	●			●	●	●			●							
8876	●					● 2			●							
9199	●					● 2										
9377	●			●		●			● 2	●						
10071	●			●		●										
10350	●			●		●										
10453	● 2	●	●?	●		● ○ 2	● 2 ○					●?				
10499				●			●									
10670	○	●	●	●	●	○					● 3					
10843	●	●	●?	●	● ●			●				●?				
11265	●	○		● 2		○		○	●	●						
11351	● 3			● 7 ○		● 6		● 2	● ○		○ 1-3			○	○	
F 84	● 6 ○	● 7 ○	● >4 ○?	● 6 ○	● 13 ○ 9	● 5 ○ 3		● 4 ○ 11	● ○	○ 3	● 3 ○ 19-61	● <6	● 3	○ 1-2		
1905	○ 2					○ 2										
A 115	●			●		● 2										
A 150						● 2										
37/135	●					● 2		● 4	●	●				●		
51/132						●										
1975	●					●			● 2	●						
Hirnach						●										
Klostergarten						●										

Sindelfingen. Verteilung der männerspezifischen Objekte auf die einzelnen Inventarnummern. ● vorhanden, ○ verschollen, ● nicht mehr identifizierbar, () Zuordnung unsicher.

Tafel 104

	Bügelfibel	Scheibefibel	Tierfibeln	Arming	Ohrring	Nadel	Perlen	Amulett	Wirtel/Perlen	Ringe	Gehängeteile	Zierscheibe	sonst. Anhänger	Wadenbinden- garnitur	Schuhgarnitur	Silberlöffel	Wirtel
8162-8192						○	○	(○)		○							
8489						●	○ 2			●							
8538/8539							●	●		○							
8566								(○)									
8648		●					○								●		
8670						●	●	○		○ 2							
8794														○			
8820				●	● 2 ○ 3	●	●			● 2		(○)	● 2				
9377		●					○										
10071	● 2		● 2				○									●	
10350	● 4						○										
10453							○										
10499		●		●	● 2 (○) 2	○	●										
10670	● 2		● 2	●	●		●	○	● 2	○ 2							● 2
10743			● 3						(●) 2								
10843						●				●							
11265	● 2			●		●	○ 2			○ 2							
11351					● 2	● 2	○ 2	○ 2		○							
F 84	● 8 ○ 2	● 4	●	● (●)	● 5 ○	● 5 (○)	● 13 ○ 7	● 3		● 9 ○ 15	● 4	●	● 2	● (6)	● 4		● 5
1905							○										
A 115							●							●	○ 2		
38/289					○ 2		○				○						

Sindelfingen. Verteilung der frauenspezifischen Objekte auf die einzelnen Inventar-
nummern. ● vorhanden, ○ verschollen, ◐ nicht mehr identifizierbar, () unsicher.

	Eisenschnalle	Silberpl./Silbert. Schnalle	Bronzeschnalle	Gürtelhaften	Schnalle m. Beschläg	Riemenzunge	Beschläg	Kamm	Pinzette	Messer	Schere	Gerät/Werkzeug	Münze	Tongefäß	Glasgefäß	Bronzegefäß
8162-8192	○ 4							●		○ 4			●			
8489	○ 2							●					●			
8538/8539													●			
8566	○									●						
8648										○						
8670	○ ●							●		●						
8794															○	●
8820												○			●	
8876								●		○ ●						
9199										●						
9377													●			
10071			(●)				●									
10350								●						● 3	(●)	
10453			○		○			●		● 3						
10499			● 3			● 3	● 4			●						
10670	○ 4	● 2								● 2			○			
10743										●						
10843										○ ●				●		
11265	● 2					○				● 2 ○ 2	○					
11351	○ 4		● 2			○		○		○ 5 ● 4	○	●		● ○ (●)	(○) 2	
F 84	● 4 ○ 19	● ○ 3	● 13 ○ 3	● 5 (○)	● 5 ○ 3	● 18 ○ 2	● 5 ○ 8	● 8 ○ >15	●	● 2 ○ 27	● (●) ○ 5	● 9 ○ 2	● 3	● 6 ○ (9)	● 5	
37/135										● 2		●				
38/289								○		○						
1975						●										
Neckarstr.											●					

Sindelfingen. Verteilung der nicht geschlechtsspezifischen Objekte auf die einzelnen Inventarnummern. ● vorhanden, ○ verschollen, ◐ nicht mehr identifizierbar, () Zuordnung unsicher.

	a	b	11	33	c	d	42	48	58	55	16	20	14	3	27	6	7	15	21	34	4	49	61	32	9	1	e	f	g	h	i
F 84/23,10	1	1				2	1						1	1	1		2		2	1	3				2					3	
8538/8539	3	2		1	5						1					2					8	2	1		1					7	1
F 84/23,7	1	6														6			1		1								4		
F 84/23,11	1			2		1															5				5				6	1	
F 84/23,4																		1		1	8				2				1		
F 84/23,8											1					1	1			5	4										1
F 84/23,6							2	2												5	4					?			2		
8670							2				1	1			1					3	1								1		
F 84/23,14											1				2					1	7										
10499			2													2	4	1	3	1	2			3	2		1		7		
F 84/23,1													1	1	4			2		9		1	2		2		1	1	4		
F 84/23,3	3	6									11	2	1	2	1	2	1	2	2	5	2			5				1	1	1	
F 84/23,2			1											1							1				1			2	2	2	
F 84/23,5																			1		3	2		2		1		1	1		
F 84/23,9					2						2	3	4				2	4		11			7		15	1			1		

Kombinationstabelle der mehrfarbigen Perlentypen (nach Koch, Schretzheim) sowie weiteren Perlentypen: a Überfangperlen, b grün zylindrisch, c Millefiori, d Amethyst, e Zickzack-Fadenaufgabe, f mandelförmig, g römisch, h Bernstein, i Metall, Knochen, Perlmutter.

Friedhof	Gräber gesamt	Gräber mit Spatha (%)	Gräber mit Sax (%)	Gräber m. Lan- zenspitze (%)	Beginn der Belegung
Hailfingen	661	25 (3,8 %)	41 (6,2 %)	39 (5,9 %)	2. Viertel 6. Jh.
Schretzheim	630	105 (16,7 %)	82 (13,4 %)	57 (9,0 %)	2. Viertel 6. Jh.
Holzgerlingen	302	12 (4,0 %)	(?)	(?)	Mitte 6. Jh.
Nusplingen	278	15 (5,4 %)	(?)	(?)	Mitte 6. Jh.
Marktoberdorf	238	24 (10,1 %)	68 (28,6 %)	20 (8,4 %)	Mitte 6. Jh.
Esslingen-Simau	222	16 (7,2 %)	52 (23,4 %)	23 (10,4 %)	Mitte 6. Jh.
Sonthheim	197	17 (8,6 %)	26 (13,2 %)	10 (5,1 %)	2. Hälfte 6. Jh.
Heidelberg- Kirchheim	149	10 (6,7 %)	13 (8,7 %)	14 (9,4 %)	Anfang 6. Jh.
Güttingen	113	9 (8,0 %)	22 (19,5 %)	3 (2,7 %)	Ende 6. Jh.
Sindelfingen	(?)	21 (-)	28 (-)	25 (-)	2. Hälfte 5. Jh.

Friedhof	Gräber gesamt	Gräber m. Nadel	Anteil (%)
Hailfingen	661	23	3,5
Schretzheim	630	29	4,6
Esslingen-Simau	222	10	4,5
Heidelberg-Kirchheim	149	7	4,7
Güttingen	113	7	6,2
Sindelfingen	(?)	12	-

Anteil der Gräber mit Waffen- und Nadelbeigaben auf einigen Gräberfeldern (Prozentzahlen gerundet; Waffenanzahl von Hailfingen, Holzgerlingen und Nusplingen nach Steuer, Bewaffnung).

Tafel 108

Fundkomplex	Jahrhundert	Spathagehänge		Waffen							Schmuck			Alltagsgegenstände					
		Spatha	Spathagehänge	Sax	Lanze	Pfeil	Schild	Dreit. Gürtelgarnitur	Sporngarnitur	Ohring	Nadel	Pfeil	Gehängeteile	Wadenbinden-garnitur	Schuhgarnitur	Kamm	Messer	Gerät	Tongefaß
1905	?	○			○														
	?	○			○						?	○							
A 115	Mitte/2.H.7.Jh. Mitte/2.H.6.Jh. 2.H.7.Jh. 1./2.Dr.7.Jh.	●		●	●								●	●	?				
A 150	2.H.7.Jh. 2.H.7.Jh.				●														
37/135	ausg. 7.Jh./ beg. 8.Jh. ? + 3 Gräber	●		●		● ● ●	●		●							●		●	
38/289	2.H.7.Jh.									○ ○		○ ○			○ ○				
51/132	Mitte/2.H.7.Jh.				●														
1956/Grab 1	?					●										●		●	
1967/Grab 1	1.H.7.Jh.	●		●			● ●										● ●		
1975/Grab 1	sp. 7.Jh./ beg. 8.Jh.	●																	
1975/Grab 4	?	●																	
1975	2.H.7.Jh. l. Dr. 6.Jh./ 1.H. 7.Jh. l. Dr. 6.Jh./ 1.H. 7.Jh. ?				●			●											
			●?					●											
		●																	

Sindelfingen, Gräberfeld „Goldberg“ (Fst. 2). Tabelle der rekonstruierten und sicheren Grabinventare.

● vorhanden, ○ verschollen.

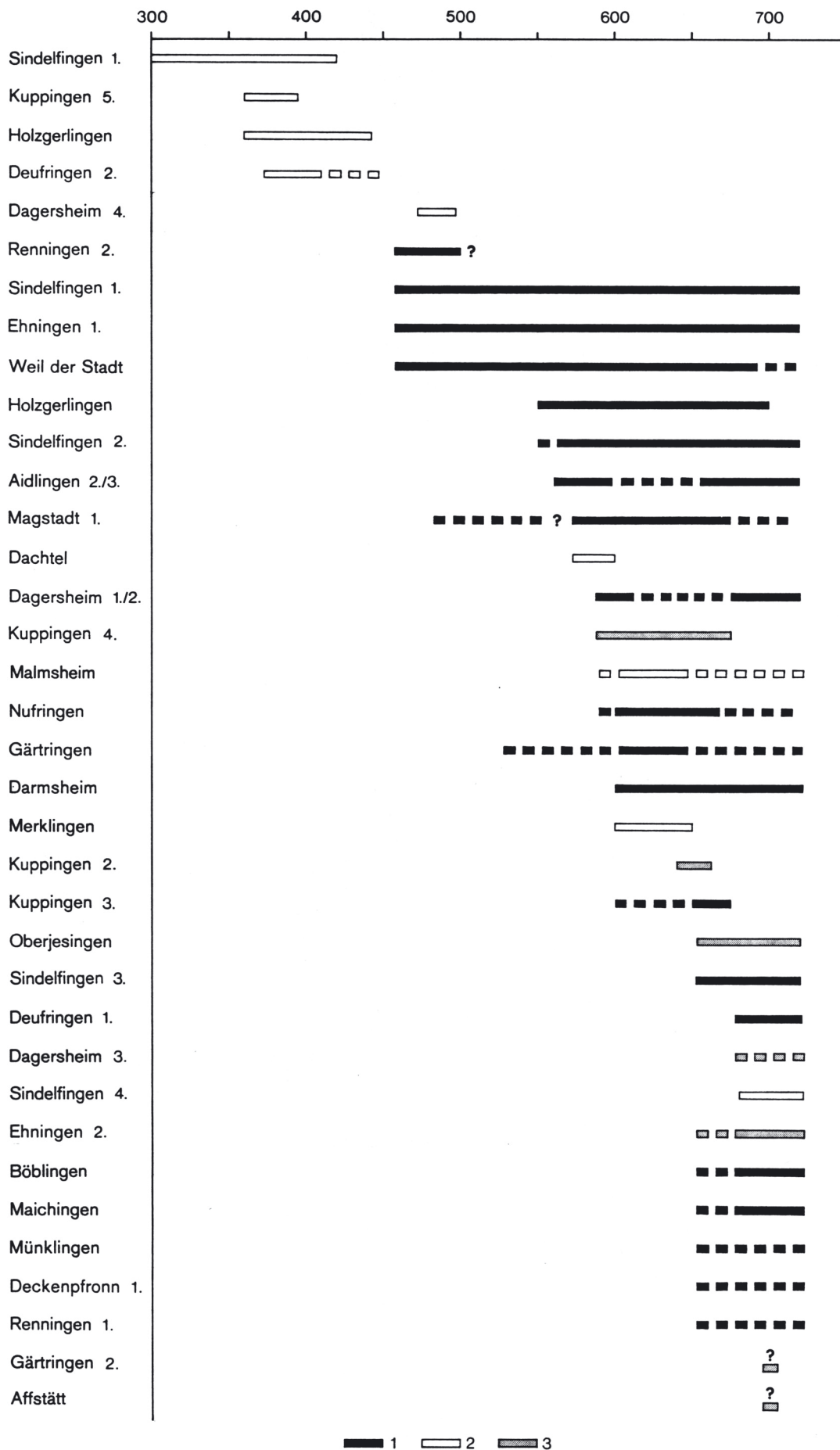

Übersichtstabelle zur Datierung der Fundstellen im Arbeitsgebiet.
 1 Gräberfeld, 2 Einzelfund, 3 Einzelgrab.